

# æra™

model: 660





**OVERVIEW**

**NAVIGATION**

**FLIGHT PLANNING**

**HAZARD AVOIDANCE**

**ADDITIONAL FEATURES**

**APPENDICES**

**INDEX**

Copyright © 2016 Garmin Ltd. or its subsidiaries. All rights reserved.

This manual reflects the operation of System Software version 1.0 or later. Some differences in operation may be observed when comparing the information in this manual to earlier or later software versions.

Garmin International, Inc., 1200 East 151st Street, Olathe, Kansas 66062, U.S.A.

Tel: 913.397.8200

Fax: 913.397.8282

Aircraft On Ground (AOG) Hotline: 913.397.0836

Aviation Dealer Technical Support: 888.606.5482

Garmin AT, Inc., 2345 Turner Road SE, Salem, OR 97302, U.S.A.

Tel: 503.581.8101

Fax 503.364.2138

Garmin (Europe) Ltd., Liberty House, Hounslow Business Park, Southampton,  
Hampshire SO40 9LR U.K.

Tel: +44 (0) 238 052 4000

Fax: +44 (0) 238 052 4004

Aviation Support: +44 (0) 370 850 1243

Garmin Corporation, No. 68, Zhangshu 2nd Road, Xizhi District, New Taipei City,  
Taiwan

Tel: 34-93-357-2608

Fax: 34-93-429-4484

Web Site Address: [www.garmin.com](http://www.garmin.com)

Except as expressly provided herein, no part of this manual may be reproduced, copied, transmitted, disseminated, downloaded or stored in any storage medium, for any purpose without the express written permission of Garmin. Garmin hereby grants permission to download a single copy of this manual and of any revision to this manual onto a hard drive or other electronic storage medium to be viewed for personal use, provided that such electronic or printed copy of this manual or revision must contain the complete text of this copyright notice and provided further that any unauthorized commercial distribution of this manual or any revision hereto is strictly prohibited.

Garmin®, ANT+®, FliteCharts®, SafeTaxi®, and MapSource® are registered trademarks of Garmin Ltd. or its subsidiaries. aera™ is a trademark of Garmin Ltd. or its subsidiaries. These trademarks may not be used without the express permission of Garmin.

This product is ANT+® certified. Visit [www.thisisant.com/directory](http://www.thisisant.com/directory) for a list of compatible products and apps.

Jeppesen® is a registered trademark of Jeppesen, Inc.

NavData™ is a trademark of Jeppesen, Inc.

AC-U-KWIK® is a registered trademark of Penton Business Media, Inc.

©2016 The Bluetooth® word mark and logos are registered trademarks owned by Bluetooth SIG, Inc. and any use of such marks by Garmin is under license. Other trademarks and trade names are those of their respective owners.





---

**WARNING:** When installing the aera™, place the unit so it does not obstruct the field of view or interfere with operating controls.

---



---

**WARNING:** The indicators represented on the Panel are based on GPS-derived data and may differ from the instruments in the aircraft.

---



---

**WARNING:** Navigation and terrain separation must NOT be predicated upon the use of the terrain function. The aera Terrain Proximity feature is NOT intended to be used as a primary reference for terrain avoidance and does not relieve the pilot from the responsibility of being aware of surroundings during flight. The Terrain Proximity feature is only to be used as an aid for terrain avoidance and is not certified for use in applications requiring a certified terrain awareness system. Terrain data is obtained from third party sources. Garmin is not able to independently verify the accuracy of the terrain data.

---



---

**WARNING:** The displayed minimum safe altitudes (MSAs) are only advisory in nature and should not be relied upon as the sole source of obstacle and terrain avoidance information. Always refer to current aeronautical charts for appropriate minimum clearance altitudes.

---



---

**WARNING:** The altitude calculated by the GPS and GLONASS receivers is geometric height above Mean Sea Level and could vary significantly from the altitude displayed by pressure altimeters.

---



---

**WARNING:** Do not use outdated database information. Databases used in the aera system must be updated regularly in order to ensure that the information remains current. Pilots using any outdated database do so entirely at their own risk.

---



---

**WARNING:** Do not use data link weather information for maneuvering in, near, or around areas of hazardous weather. Information contained within data link weather products may not accurately depict current weather conditions.

---



---

**WARNING:** Do not use the indicated data link weather product age to determine the age of the weather information shown by the data link weather product. Due to time delays inherent in gathering and processing weather data for data link transmission, the weather information shown by the data link weather product may be significantly older than the indicated weather product age.

---



---

**WARNING:** To reduce the risk of unsafe operation, carefully review and understand all aspects of the aera Pilot's Guide documentation and the Pilot's Operating Handbook of the aircraft. Thoroughly practice basic operation prior to actual use. During flight operations, carefully compare indications from the aera to all available navigation sources, including the information from other NAVAIDs, visual sightings, charts, etc. For safety purposes, always resolve any discrepancies before continuing navigation.

---



---

**WARNING:** The Garmin aera has a very high degree of functional integrity. However, the pilot must recognize that providing monitoring and/or self-test capability for all conceivable system failures is not practical. Although unlikely, it may be possible for erroneous operation to occur without a fault indication shown by the aera. It is thus the responsibility of the pilot to detect such an occurrence by means of cross-checking with all redundant or correlated information available in the cockpit.

---



---

**WARNING:** For safety reasons, aera operational procedures must be learned on the ground.

---



---

**WARNING:** The government entities operating the satellite-based navigation systems (GPS/GLONASS) are solely responsible for their accuracy and maintenance. The satellite-based navigation systems are subject to changes which could affect the accuracy and performance of all GPS/GLONASS equipment. Portions of the system utilize GPS/GLONASS as a precision electronic NAVigation AID (NAVAID). Therefore, as with all NAVAIDs, information presented by the system can be misused or misinterpreted and, therefore, become unsafe.

---



---

**WARNING:** The data contained in the terrain and obstacle databases comes from government agencies. Garmin accurately processes and cross-validates the data, but cannot guarantee the accuracy and completeness of the data.

---



---

**WARNING:** Do not use basemap (land and water data) information for primary navigation. Basemap data is intended only to supplement other approved navigation data sources and should be considered as an aid to enhance situational awareness.

---



---

**WARNING:** Do not rely solely upon the display of traffic information for collision avoidance maneuvering. The traffic display does not provide collision avoidance resolution advisories and does not, under any circumstances or conditions, relieve the pilot's responsibility to see and avoid other aircraft.

---



---

**WARNING:** Do not rely solely upon the display of traffic information to accurately depict all of the traffic within range of the aircraft. Due to lack of equipment, poor signal reception, and/or inaccurate information from aircraft or ground stations, traffic may be present that is not represented on the display.

---



---

**CAUTION:** The display uses a lens coated with a special coating that is very sensitive to abrasive cleaners. **AVOID CHEMICAL CLEANERS AND SOLVENTS THAT WILL HARM THE SPECIAL COATING.** It is very important when cleaning the touchscreen to use a clean, lint-free cloth (lightly dampened with water, if necessary).

---



---

**CAUTION:** The Garmin aera does not contain any user-serviceable parts. Repairs should only be made by an authorized Garmin service center. Unauthorized repairs or modifications could void both the warranty and the pilot's authority to operate this device under FAA/FCC regulations.

---



---

**NOTE:** All visual depictions contained within this document, including screen images of the aera panel and displays, are subject to change and may not reflect the most current aera system and aviation databases. Depictions of equipment may differ slightly from the actual equipment.

---





---

**NOTE:** This product, its packaging, and its components contain chemicals known to the State of California to cause cancer, birth defects, or reproductive harm. This notice is being provided in accordance with California's Proposition 65. For questions or additional information, please refer to our web site at [www.garmin.com/prop65](http://www.garmin.com/prop65).

---



---

**NOTE:** Use of polarized eyewear may cause the display to appear dim or blank.

---



---

**NOTE:** Temporary Flight Restriction (TFR) data is provided by the FAA and may not be updated outside of normal business hours. Confirm data currency through alternate sources and contact the local FSS for interpretation of TFR data.

---

Blank Page

<b>Part Number</b>	<b>Change Summary</b>
190-02017-20	Initial release

<b>Rev</b>	<b>Date</b>	<b>Description</b>
A	March, 2016	Production Release

Blank Page

**SECTION 1 OVERVIEW** ..... 1

**1.1 Unit Overview** ..... 1

**1.2 Getting Started**..... 2

        Battery Installation ..... 2

        Charging the Battery ..... 3

        Mounting the aera in the Aircraft ..... 3

        Turning the Unit On/Off ..... 4

        GNSS Receiver Status ..... 4

        Display Orientation..... 6

**1.3 Operation** ..... 7

        Basic Touchscreen Operation ..... 7

        Dedicated Page Icons ..... 8

        Main Menu ..... 10

**1.4 Accessing System Functionality** ..... 14

        Option Menus ..... 14

        Data Entry ..... 15

**1.5 Using Map Displays** ..... 17

        Map Range ..... 17

        Map Panning ..... 19

        Map Overlays ..... 21

        Map Symbols ..... 22

        MAP Detail ..... 22

**1.6 System Settings** ..... 23

        Display ..... 23

        Sound ..... 25

        Map Setup ..... 26

        Data Link Setup ..... 27

        Bluetooth® ..... 27

        WiFi Setup ..... 28

        3d Vision Setup ..... 28

        Additional Settings ..... 28

**1.7 Nearest Airport Criteria Settings** ..... 30

**1.8 Present Position** ..... 31

**1.9 New Location** ..... 32

**1.10 Simulator Mode** ..... 32

**SECTION 2 NAVIGATION** ..... 35

**2.1 Introduction** ..... 35

        Data Fields ..... 36

        Compass Arc ..... 38

**2.2 3D Vision** ..... 39

        3D Vision Operation ..... 40

<b>2.3 Vertical Navigation (VNAV)</b> .....	43
Using the VNAV Feature .....	44
<b>2.4 Map Display Setup</b> .....	46
Map Orientation.....	46
Airports, Navaids, Cities & Roads .....	47
Airways.....	48
<b>2.5 Waypoints</b> .....	49
Nearest Information .....	52
Weather and NOTAM Information (Optional) .....	54
Accessing Additional information.....	56
<b>2.6 Direct-to Navigation</b> .....	67
<b>SECTION 3 FLIGHT PLANNING</b> .....	69
<b>3.1 Introduction</b> .....	69
Data Fields.....	69
<b>3.2 Flight Plan Creation</b> .....	70
Adding Waypoints to an Existing Flight Plan.....	72
<b>3.3 Flight Plan Storage</b> .....	74
<b>3.4 Flight Plan Activation</b> .....	74
Editing Speed and Fuel Flow.....	75
Copying Flight Plans.....	76
Inverting a Flight Plan .....	77
<b>3.5 Approaches</b> .....	77
Selecting an Approach.....	78
Activating Vectors-to-Final.....	80
<b>SECTION 4 HAZARD AVOIDANCE</b> .....	81
<b>4.1 Weather</b> .....	81
Data Link weather (FIS-B).....	81
<b>4.2 Terrain</b> .....	93
Terrain Information.....	94
Obstacle Information.....	94
Terrain and Obstacle Color Code.....	95
Terrain Views.....	95
Terrain Alerts & Setup.....	96
<b>4.3 Traffic</b> .....	99
Traffic Information Service (TIS-A) .....	99
Traffic Ground Track .....	100
Displaying Traffic Data .....	100
Data Link Traffic .....	101

**SECTION 5 ADDITIONAL FEATURES** ..... 113

**5.1 SafeTaxi** ..... 113

        SafeTaxi Cycle Number and Revision ..... 114

**5.2 Airport Directory Data** ..... 114

        Fuel Prices ..... 116

**SECTION 6 APPENDICES** ..... 117

**Appendix A: Messages, Alerts & Data Field Options** ..... 117

        Miscellaneous Message Advisories ..... 117

        Airspace Messages ..... 119

        Data Field & Numeric Data Options ..... 119

        Aural Alerts ..... 121

**Appendix B: Abnormal Operation** ..... 123

        Loss of GNSS Position ..... 123

        Hazard Display with Loss of GNSS Position ..... 123

**Appendix C: Managing Files and Databases** ..... 125

        Connecting to a Computer ..... 125

        Managing Files ..... 126

        MicroSD™ Card Use (Optional) ..... 127

        Database Types ..... 128

        Database Purchase, Installation, and Updates ..... 130

**Appendix D: Installation and Interfacing** ..... 133

        Mounting the aera in the Aircraft ..... 133

        Connecting to a Garmin VHF Comm Radio ..... 137

        Information about USB Drivers ..... 139

        Interfacing ..... 139

        Connecting to a GTX 330 Mode S Transponder ..... 141

        Connecting to a GDL 39/GDL 39R ..... 142

        Connecting to a GTX 345 ..... 145

**Appendix E: Battery and Care Information** ..... 147

        Battery Information ..... 147

        Changing the Fuse ..... 147

        Cleaning the Casing ..... 148

        Cleaning the Touchscreen ..... 148

        Protecting the Unit ..... 148

        Avoiding Theft ..... 149

**Appendix F: General TIS-A Information** ..... 151

        TIS-A vs. TAS/TCAS ..... 151

        TIS-A Limitations ..... 152

**Appendix G: Utilities** ..... 155

- Flight Log ..... 155
- Track Log ..... 156
- Track Vector ..... 158
- E6B Calculator ..... 159
- Aircraft Profile ..... 161
- Weight & Balance ..... 162
- Proximity Waypoints ..... 163

**Appendix H: Display Symbols** ..... 165

- VFR Symbols ..... 165
- IFR Symbols ..... 166
- Airspace Symbols ..... 168

**Appendix I: Map Datum and Location Formats** ..... 171

- Map Datums ..... 171
- Location Formats ..... 171

**Appendix J: Glossary** ..... 173

**Appendix K: License Agreement and Warranty** ..... 179

- Contact Garmin ..... 179
- Software License Agreement ..... 179
- Limited Warranty ..... 179
- AOPA Airport Directory Notice ..... 180
- AC-U-KWIK LICENSE AGREEMENT ..... 181
- FCC Compliance ..... 181
- Industry Canada Compliance ..... 181
- Radiation Exposure Statement ..... 182

**Index** ..... Index-1



# SECTION 1 OVERVIEW

## 1.1 UNIT OVERVIEW

The aera 660 presents GNSS-derived analog flight instrumentation, position, navigation, and hazard avoidance information to the pilot using a 5" display with a capacitive touch screen.



Unit Overview

## 1.2 GETTING STARTED

### BATTERY INSTALLATION



**NOTE:** Refer to Appendix E for additional battery information.



**CAUTION:** Always keep the battery installed when the unit is on.



**WARNING:** The product contains a lithium-ion battery. To prevent damage, remove the unit from the aircraft or vehicle when exiting or store it out of direct sunlight.

#### Installing the battery:

- 1) Locate the lithium-ion battery that came in the product box.
- 2) Locate the metal contacts on the end of the lithium-ion battery.
- 3) Insert the battery so that the metal contacts on the battery line-up with the metal contacts inside the battery compartment.
- 4) Insert the battery into the battery compartment, and push until it clicks into place.



Unit Overview - Battery

## CHARGING THE BATTERY



**NOTE:** While in Charge Mode, the unit draws a current from the aircraft. To avoid discharging the aircraft's battery, disconnect the external power cable from the unit when not in use for several days.

Charge the aera for at least 4 hours before using on battery power. Charge the battery by connecting the aviation power cable, the USB cable, an AC adapter, or use a stand-alone battery charger (optional accessory).

Plug the unit into a 12-Volt or 24-Volt connector to charge. The unit can be used while it is charging. Charge the unit within the following temperature range: 41° to 95°F (5° to 35°C).

- 1) Mount the aera 660 in the aircraft and connect the power cable to the aircraft power outlet (cigarette lighter receptacle).
- 2) Route the power cable so that it does not interfere with aircraft operation. The unit begins charging as soon as external power is applied.

## USING CHARGE MODE

Applying external power to the aera automatically turns on the unit for full operation. If the battery is present and needs to be charged, the external power source charges the battery while the unit is in use.

If you do not want to use the unit, but you would like to charge the battery, you can put the unit into Charge Mode. Connect the unit to an external power supply. Press and hold the  **POWER** Button. Instead of completely turning off, the unit now goes into Charge Mode.

The unit will run cooler and may allow more current to be available for charging the battery while in Charge Mode.

## MOUNTING THE aera IN THE AIRCRAFT

Refer to Appendix D 'Installation & Interfacing' for information on mounting the aera in the aircraft.

## TURNING THE UNIT ON/OFF

Press the **POWER** Button to turn the unit on. Press and hold the **POWER** Button to turn the unit off.

The first time the unit is turned on, the receiver must collect satellite data and establish its present location. To ensure proper initialization, the aera is shipped from the factory in AutoLocate mode, which allows the receiver to “find itself” anywhere in the world.

During initialization, current database information is displayed. Database information includes valid operating dates, cycle number, and database type. When this information has been reviewed for currency (to ensure that no databases have expired), the pilot is prompted to continue.

Touching the **Press To Accept** Button acknowledges this information, and the **Main Menu** is displayed.



Database Initialization

## GNSS RECEIVER STATUS

The receiver status displays one of the following conditions:

- Autolocate—Receiver is looking for any satellite whose almanac has been collected, which can take up to 5 minutes
- Searching the Sky—Receiver is looking for satellites
- Acquiring Satellites—Receiver is looking for and collecting data from satellites visible at its last known or initialized location, but has not acquired a fix

- 2D GNSS Location—At least three satellites have been acquired and a two-dimensional location fix has been calculated. “2D Differential” appears when you are receiving DGPS corrections in 2D mode
- 3D GNSS Location—At least four satellites have been acquired and a three-dimensional fix has been calculated. “3D Differential” appears when you are receiving DGPS corrections in 3D mode
- Lost Satellite Reception—the receiver is no longer tracking enough satellites for a 2D or 3D fix

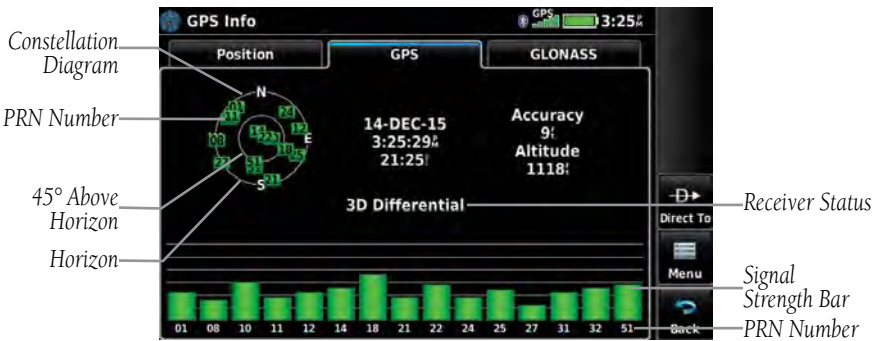

**GPS Status**

**Viewing the GNSS status:**

From the **Main Menu**, touch **GPS Info** > **GPS** Tab.

**ACQUIRING SATELLITES**

The  bars on the **Main Menu** indicate the GNSS signal strength.

When the receiver is in the process of acquiring enough satellite signals for navigation, the receiver uses satellite orbital data (collected continuously from the satellites) and last known position to determine the satellites that should be in view. 'Acquiring Satellites' is indicated as the solution until a sufficient number of satellites have been acquired for computing a solution.

When the receiver is in the process of acquiring a 3D differential GNSS solution, '3D GNSS Location' is indicated as the solution until the 3D differential fix has finished acquisition.

## SATELLITE INFORMATION

Satellites currently in view are shown at their respective positions on a satellite constellation diagram. The outer circle of the constellation diagram represents the horizon, the inner circle represents 45° above the horizon, and the center point shows the position directly overhead. Each satellite is represented by a square containing the Pseudo-Random Noise (PRN) number (i.e., satellite identification number).

GPS Info can be helpful in troubleshooting weak (or missing) signal levels due to poor satellite coverage or installation problems. As the GNSS receiver locks onto satellites, a signal strength bar is displayed for each satellite in view, with the appropriate satellite PRN number (01-32 or 33-64 for WAAS) (65-99 for GLONASS) below each bar. The progress of satellite acquisition is shown in three stages, as indicated by signal bar appearance:

- No bar—Receiver is looking for the indicated satellite
- Gray bar—Receiver has collected the necessary data and the satellite signal can be used
- Green bar—Satellite is being used for the GNSS solution

## DISPLAY ORIENTATION

The aera 660 can be viewed in either Portrait or Landscape Mode.

### Changing the display orientation:

- 1) From the **Main Menu**, touch **Tools** > **Setup** > **Display**

**Or:**

Press the Power Button once quickly.

- 2) Touch **Landscape** or **Portrait**.

# 1.3 OPERATION

## BASIC TOUCHSCREEN OPERATION

Touch the desired selection. The icon, menu option, etc., will momentarily turn blue when selected.



Basic Touchscreen Operation

## SCROLLING AND PANNING

### Scrolling and panning on the touchscreen:

Drag up or down to scroll menus, documents, etc.

**Or:**

Drag in any direction to pan maps or charts.

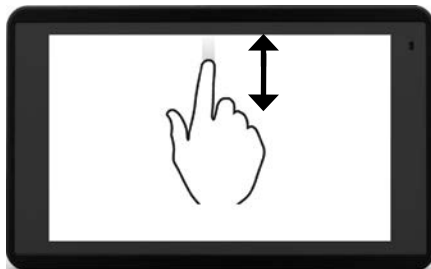

Scroll

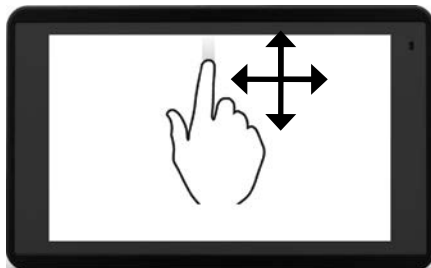

Pan

## ZOOMING

**Zooming in and out on the touchscreen map displays:**

Pinch fingers together (zoom out), or pull fingers apart (zoom in).



**Zoom Out**



**Zoom In**

## DEDICATED PAGE ICONS







Dedicated Page Icons are located vertically on the right side of the screen in landscape mode or horizontally along the bottom of the screen in portrait mode.







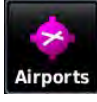











Dedicated Page Icons





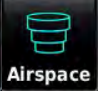

Nearest Airports Page

	Scroll up	OR		Touch to zoom out
	Scroll down	OR		Touch to zoom in
	Nearest Group Icons (Nearest Page Only)	OR		Weather Group Icons (Weather Page Only)

			OR			
						
						

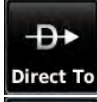
	Direct-to function	OR		Cancel map pointer
	Page menu			
	<ul style="list-style-type: none"> <li>• Previous Screen</li> <li>• Main Menu (Touch and Hold)</li> </ul>			

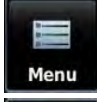









## MAIN MENU



Touch and hold the **Back** icon at any time to display the **Main Menu**.

## MAIN MENU ICONS











Touch the following icons to display the associated page or menu:

	<b>Map</b>	Displays the Map View.
	<b>Charts</b>	Displays the VFR or IFR charts.
	<b>3D Vision</b>	Displays 3D Vision.
	<b>Nearest</b>	Displays the Nearest Page
	<b>Waypoint</b>	Displays the Waypoint Information.
	<b>Flight Plan List</b>	Displays the Flight Plan List.
	<b>Active Flight Plan</b>	Displays the Active Flight Plan.
	<b>Traffic</b>	Displays the dedicated Traffic Page.
	<b>Terrain</b>	Displays the Terrain View.
	<b>Weather</b>	Displays Weather Map Page
	<b>GPS Info</b>	Displays current position and satellite status.
	<b>Tools</b>	Displays second-level Tools Icons.

## NEAREST ICONS

From the **Main Menu**, touch the  icon to access the Nearest Page.







Touch the following Nearest Group Icons to display the associated function:

	<b>Airport</b>	Displays nearest airports.
	<b>Airport WX</b>	Displays nearest airport weather.
	<b>VOR</b>	Displays nearest VORs.
	<b>NDB</b>	Displays nearest NDBs.
	<b>Intersection</b>	Displays nearest intersections.
	<b>VRP</b>	Displays nearest Visual Reporting Point (VRP).
	<b>User WPT</b>	Displays nearest user waypoints.
	<b>City</b>	Displays nearest cities.
	<b>ARTCC</b>	Displays nearest ARTCCs (Air Route Traffic Control Centers).
	<b>FSS</b>	Displays nearest Flight Service Stations (FSS).
	<b>Airspace</b>	Displays nearest airspace.

## WEATHER ICONS

From the **Main Menu**, touch the **Weather** icon to access the Weather Page.

Touch the following Weather Group Icons to display the weather product:

	<b>NEXRAD Radar</b>	Displays NEXRAD (NEXT-generation RADar).
	<b>Winds Aloft</b>	Displays Winds Aloft.
	<b>Temps Aloft</b>	Displays Temperatures Aloft.
	<b>METAR</b>	Displays METARs.
	<b>AIRMET</b>	Displays AIRMETs.
	<b>SIGMET</b>	Displays SIGMETs.

**TFR**

Displays TFRs.

**Pilot Reports**

Displays PIREPs.

## TOOLS

From the **Main Menu**, touch the **Tools** Icon to access the second-level Tools icons.

Touch the following second-level icons to display the associated function:

**Setup**

Displays third-level Setup Icons.

**User WPT**

Displays User Waypoints and Proximity Waypoints.

**Flight Log**

Displays Flight Logs.

**Track Log**

Displays Track Logs.

**VNAV**

Displays Vertical Navigation.

**Profile**

Displays Aircraft Profiles.

**E6B**

Displays the E6B Calculator.

**Weight/Bal**

Displays the Weight &amp; Balance.

**Data Link**

Displays Data Link Information.

**Downloads**

Displays available downloads.

**User Timer**

Displays User Timer.

**Database**

Displays database and software version information.















**VIRB**

Displays VIRB Remote Page.

## SETUP ICONS

From the **Main Menu**, touch the **Tools > Setup** to access the third-level Setup Icons.

Touch the following third-level icons to perform the associated function:

	<b>Display</b>	Displays backlight intensity/timeout and color mode settings.
	<b>Sound</b>	Displays sound settings.
	<b>Units</b>	Displays unit settings.
	<b>Time</b>	Displays time settings.
	<b>Map</b>	Displays Navigation Map settings.
	<b>Position</b>	Displays position settings.
	<b>Interface</b>	Displays interface settings.
	<b>Alarms</b>	Displays alarm settings.
	<b>Airspace</b>	Displays Special Use Airspace alarm settings.
	<b>Data Link</b>	Displays Data Link Settings.
	<b>Bluetooth®</b>	Displays Bluetooth connection settings.
	<b>WiFi</b>	Displays WiFi connection settings.
	<b>Power</b>	Displays Power Loss Warning settings.
	<b>3D Vision</b>	Displays 3D Vision settings.

## 1.4 ACCESSING SYSTEM FUNCTIONALITY

### OPTION MENUS

The aera 660 has a dedicated  icon that displays a context-sensitive list of menu options available.

#### Navigating the option menu:





- 1 Touch the  icon
- 2 Touch the desired menu option.



### DATA ENTRY

#### DATA ENTRY ICONS

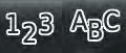
The following icons are displayed in the data entry window.

	<b>Enter</b>	Exits the keypad function and accepts the changes.
	<b>Backspace</b>	Erases the current data.
	<b>Numeric/Alpha</b>	Displays the numeric or alpha keypad.
	<b>Cancel</b>	Cancel a value that has been edited.

#### Entering alphanumeric data:

- 1 When alphanumeric data can be entered, a keypad will appear after touching the desired datafield.
- 2 Touch the keypad letters or numbers to enter the desired data.
- 3 Touch **Enter**.



### Entering predetermined data options:

- 1 Touch the Data Option Button to display a vertical list of data options (if applicable), or toggle two data options (i.e., On/Off).
- 2 If using the vertical list, touch the desired data option from the list.





# 1.5 USING MAP DISPLAYS



**NOTE:** Refer to the GPS Navigation section for more information on Map Display Setup.



Map displays are used extensively in the aera to provide situational awareness in flight. Most aera maps can display the following information:

- Airports, NAVAIDs, airspaces, airways, land data (highways, cities, lakes, rivers, borders, etc.) with names
- Map Pointer information (distance and bearing to pointer, location of pointer, name, and other pertinent information)
- Map range
- Aircraft icon (representing present position)
- Flight plan legs
- User waypoints
- Track vector
- Topography data

## MAP RANGE

There are 23 different map ranges available, from 200 feet to 800 nm. The current map range is indicated in the lower right. The scale bar represents the map scale.

### Changing the map range:

Use the  (out) or  (in) icons to zoom 'out' (increasing), or zoom 'in' (decreasing).

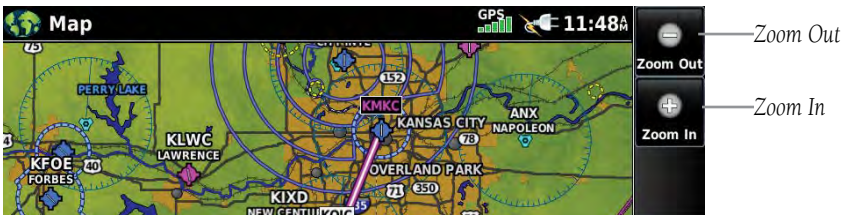

Or:

Pinch fingers together (zoom out), or pull fingers apart (zoom in).

## OVERZOOM

When the selected range exceeds the resolution of the map data, 'overzoom' appears below the map range scale.

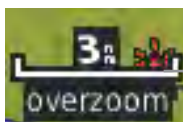

Scale Bar Representing a Map Scale of 3 nm Per Scale Width.

Map Range/Overzoom

## AUTO ZOOM

Auto Zoom allows the aera 660 to change the map display range to the smallest range clearly showing the active waypoint. Auto Zoom can be overridden by adjusting the range and remains that way until the active waypoint changes, a terrain or traffic alert occurs, or the aircraft takes off.

### Enabling/disabling auto zoom:

- 1) From the **Main Menu**, touch **Map > Menu > Set Up Map**.
- 2) If necessary, touch the **Map Group** Button and touch **General**.
- 3) Touch the **General**.
- 4) Touch the '**On/Off**' Data Option Button for 'Autozoom'.



Autozoom-Toggle

Map Group Button

## MAP PANNING

Map panning allows the pilot to:

- View parts of the map outside the displayed range without adjusting the map range
- Highlight and select locations on the map
- Review information for a selected airport, NAVAID or user waypoint
- Designate locations for use in flight planning
- View airspace and airway information

When the panning function is selected by touching anywhere on the Map, the Map Pointer is displayed. An Information Window also appears at the bottom of the map display showing the bearing, distance and time to the pointer from the aircraft's present position, the elevation of the land at the position of the pointer, or the object's (airports, obstacles, etc) elevation, if known.

When the Map Pointer is over a map feature, the map feature is highlighted, an information box appears on the map, and the highlighted map feature is displayed on the Map Feature Button (even if the name was not originally displayed on the map).

Touching the **Map Feature** Button displays additional information for the highlighted map feature. If multiple features are present at the Map Pointer position, green arrows will appear on the Map Feature Button. Touching the  will cycle through the list of map features present at that position.

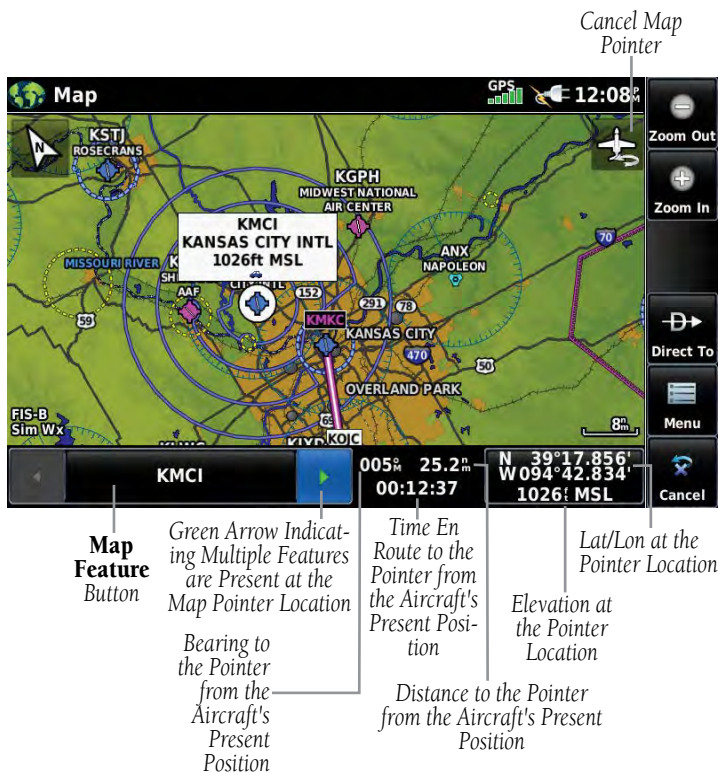

### Map Panning (Navigation Map)





#### Activating the map pointer:

While viewing a Map Display, touch anywhere on the map to activate the map pointer. Touch the icon to cancel the map pointer.

#### Panning the map:

While viewing a Map Display, touch anywhere on the map and drag.

### Reviewing information for a map feature:

- 1 While viewing a Map Display, touch anywhere on the map to activate the map pointer. When the Map Pointer is over a map feature, the map feature is highlighted, an information box appears on the map, and the highlighted map feature is displayed on the Map Feature Button. If multiple features are present at the Map Pointer position, green arrows will appear on the Map Feature Button.
- 2 If necessary, touch the   buttons to cycle through the list of map features present at that position. Touching the   buttons changes the highlight and description.
- 3 Touch the Map Feature Button to review information for the Map Feature.
- 4 If desired touch **Direct-to**  to navigate to the map feature.



## MAP OVERLAYS

The VFR, IFR, Terrain, Topography, or Weather map overlays can be displayed or removed.

### Displaying/removing map overlays:

- 1) From the **Main Menu**, touch **Map > Menu**.
- 2) Touch **VFR**, **IFR**, **Terrain**, **Topo Shading**, **Weather**, or **Animate Weather** to display or remove the map overlay.

## MAP SYMBOLS

Refer to Appendix H for a list of map symbols.

## MAP DETAIL

The map can be adjusted to declutter (remove unwanted items, such as highways) on the map.

### Adjusting the declutter level of the navigation map:

- 1) From the **Main Menu**, touch **Map > Menu**.
- 2) Touch the desired **Map Detail** level (-1, -2, -3) on the right side of the screen. The currently selected level is highlighted green.



Map Detail

# 1.6 SYSTEM SETTINGS

The third-level **Setup** Icons allow management of the following system parameters:

- Display
- Sound
- Units
- Time
- Map
- Position
- Interface
- Alarms
- Airpace
- Data Link
- Bluetooth
- WiFi
- Power
- 3D Vision

### Restoring system setting defaults:

- 1) From the **Main Menu**, touch **Tools > Setup**.
- 2) Touch the desired Setup Icon (**Display, Sound, Units, Time, Map, Position, Interface, Alarms, Airspace, Data Link, Bluetooth, or Power**).
- 3) Touch **Menu > Restore Default**.

## DISPLAY



Display Setup

## DISPLAY ORIENTATION

The aera 660 can be viewed in either Portrait or Landscape Mode.

### Changing the display orientation:

From the **Main Menu**, touch **Tools** > **Setup** > **Display**

**Or:**

Press the Power Button once quickly.

## BACKLIGHT INTENSITY

### Adjusting backlight intensity:

- 1) From the **Main Menu**, touch **Tools** > **Setup** > **Display**.
- 2) Touch '+' or '-' or touch and drag the percentage triangle to adjust the desired backlight intensity percentage.

**Or:**

Press the  **POWER** Button to quickly access the backlight intensity.

## BACKLIGHT TIMEOUT

When running on battery power, after a specified period of inactivity the backlight will turn off to save power.

### Adjusting backlight timeout:

- 1) From the **Main Menu**, touch **Tools** > **Setup** > **Display**.
- 2) Touch the '**Backlight Timeout**' Data Option Button, and touch the desired option from the list (**Stays On**, **15 Seconds**, **30 Seconds**, **1 Minute**, or **2 Minutes**).

## MAP COLOR MODE

### Adjusting the map color mode:

- 1) From the **Main Menu**, touch **Tools** > **Setup** > **Display**.
- 2) Touch the '**Map Color Mode**' Data Option Button, and touch the desired option from the list (**Auto**, **Day**, or **Night**).



## CHART COLOR MODE

### Adjusting the chart color mode:

- 1) From the **Main Menu**, touch **Tools** > **Setup** > **Display**.
- 2) Touch the '**Chart Color Mode**' Data Option Button, and touch the desired option from the list (**Auto**, **Day**, or **Night**).

## ENABLING SCREENSHOTS

### Enabling/disabling screenshots:

- 1) From the **Main Menu**, touch **Tools** > **Setup** > **Display**.
- 2) Touch **On** or **Off** in the 'Screenshot' field. An SD card is required.

## AIRCRAFT POSITION

### Showing/hiding the aircraft position:

- 1) From the **Main Menu**, touch **Tools** > **Setup** > **Display**.
- 2) Touch **Show** or **Hide** in the 'Aircraft Position' field.

## SOUND

Sound is broken down into 'Master', 'Alert', and 'Message'. 'Master' controls ALL sound. 'Alerts' and 'Message' are a percentage of the 'Master' sound. 'Alerts' refers to navigation phrases (e.g. "Pull Up"). The Terrain Alerts and Key Tones can also be toggled enabled or disabled.



Sound Setup

### Adjusting the sound:

- 1) From the **Main Menu**, touch **Tools** > **Setup** > **Sound**.
- 2) Touch '+' or '-' or touch and drag the percentage triangle to adjust the desired volume percentage.

**Or:**

Touch the  icon to mute the **Master**, **Alerts**, or **Message** audio. A blue 'X' will appear over the icon.

**Or:**

Touch **Enable** to enable/disable Terrain Audio or Key Tone.

**Or:**

Press the  **POWER** Button to quickly access the **Master** volume/mute.

### Muting sound:

See the 'Adjusting the Sound' procedure above.

## MAP SETUP

---

### AUTOZOOM

#### Enabling/disabling autozoom:

- 1) From the **Main Menu**, touch **Tools** > **Setup** > **Map**.
- 2) Touch **On** or **Off** in the 'Autozoom' field.

### ORIENTATION

#### Adjusting the map orientation:

- 1) From the **Main Menu**, touch **Tools** > **Setup** > **Map**.
- 2) Touch the '**Orientation**' Data Option Button, and touch the desired option from the list (**North Up**, **Track Up**, or **DTK Up**).

### COMPASS ARC

#### Enabling/disabling the compass arc:

- 1) From the **Main Menu**, touch **Tools** > **Setup** > **Map**.
- 2) Touch **On** or **Off** in the 'Compass Arc' field.

## NORTH UP ABOVE

### Setting North Up Above:

- 1) From the **Main Menu**, touch **Tools > Setup > Map**.
- 2) Touch the '**North Up Above**' Data Option Button, and touch the desired nautical milage.

## NORTH UP ON GROUND

### Enabling/disabling North Up On Ground:

- 1) From the **Main Menu**, touch **Tools > Setup > Map**.
- 2) Touch **On** or **Off** in the 'North Up On Ground' field.

## DATA LINK SETUP

### AIRCRAFT TYPE

#### Setting the aircraft type:

- 1) From the **Main Menu**, touch **Tools > Setup > Data Link**.
- 2) Touch **Pressurized** in the 'Aircraft Type' field to toggle it On/Off.

### ADS-B TRAFFIC DATA

#### Enabling/disabling ADS-B Traffic Data:

- 1) From the **Main Menu**, touch **Tools > Setup > Data Link**.
- 2) Touch **Enabled** in the 'ADS-B Traffic Data' field to toggle enable/disable it.

## BLUETOOTH®



**NOTE:** Only one Bluetooth connection is allowed at a time.

### Connecting/Pairing to a weather/traffic device via Bluetooth:

- 1) Ensure the weather/traffic device is turned ON. From the **Main Menu**, touch **Tools > Setup > Bluetooth > On**.
- 2) Touch **Not Paired** next to the GDL Device. A Bluetooth Passkey window will open.
- 3) Touch **OK**. The weather/traffic device is now connected.

## WIFI SETUP

---

### Connecting to a WiFi network:

- 1) From the **Main Menu**, touch **Tools** > **Setup** > **Wi-Fi** > **On**.
- 2) Touch **Add Network**.
- 3) Touch the desired network to add.
- 4) If necessary, enter the password using the keypad and touch **Enter**.

### Removing a WiFi network:

- 1) From the **Main Menu**, touch **Tools** > **Setup** > **Wi-Fi**.
- 2) Touch the network button.
- 3) Touch **Remove**.
- 4) Touch **Yes**.

### Turning WiFi off:

- 1) From the **Main Menu**, touch **Tools** > **Setup** > **Wi-Fi**.
- 2) Touch **Off**.

## 3D VISION SETUP

---

### Setting up 3D Vision:

- 1) From the **Main Menu**, touch **Tools** > **Setup** > **3D Vision**.
- 2) Touch the '**Bug Indicator**' Data Option Button, and touch the desired option from the list (**User Selected**, **Bearing**, **Desired Track**, or **Off**).
- 3) Touch the desired settings to display (**Ground Speed**, **Altitude**, **Heading**, **Lateral Deviation**, **Vertical Deviation**, **Vertical Speed**, **Slip/Skid**, or **Synthetic Vision**).
- 4) Touch **On/Off** to enable/disable '**Panning Timeout**'.

## ADDITIONAL SETTINGS

---

### Changing settings (Units, Time, Position, Interface, Alarms, Airspace, and Power):

- 1) From the **Main Menu**, touch **Tools** > **Setup**.
- 2) Touch the desired Settings Icon (**Units**, **Time**, **Position**, **Interface**, **Alarms**, **Airspace**, or **Power**).

3) Touch the desired setting to change. Touch the desired setting from the vertical list (if applicable).

**Or:**

Use the keypad to enter numerical values and touch **Enter** (if applicable).

**Or:**

Touch **On** or **Off** to enable or disable a feature (if applicable).

4) Touch and hold the **Back** Icon to return to the **Main Menu**.

Icon	Available Settings
<b>Display</b>	Display Orientation, Backlight Intensity, Backlight Timeout, Map Color Mode, Chart Color Mode, Screenshot, Aircraft Position
<b>Sound</b>	Master Volume, Alert Volume, Message Volume, Terrain Audio, Key Tone
<b>Units</b>	Distance, Speed, Direction Display, Temperature, Altitude, Vertical Speed, Pressure, Fluid Volume
<b>Time</b>	Time Format, Auto UTC Offset
<b>Map</b>	Autozoom, Orientation, Compass Arc, North Up Above, North Up On Ground
<b>Position</b>	Location Format, Map Datum, Heading, Magnetic Variation
<b>Interface</b>	Serial Port, Serial Data Format
<b>Alarms</b>	Arrival, Next Waypoint, Proximity Waypoint, Fuel Tank Reminder
<b>Airspace Alarms</b>	Class B/TMA, Class C/TCA, Class D, Restricted, MOA, Other/ADIZ, Parachute Area
<b>Data Link</b>	Aircraft type, ADS-B Traffic Data
<b>Bluetooth</b>	Bluetooth setup
<b>WiFi</b>	WiFi setup
<b>Power</b>	Power Loss Warning
<b>3D Vision</b>	Bug Indicator, Ground Speed, Altitude, Heading, Lateral Deviation, Vertical Deviation, Vertical Speed, Slip/Skid, Synthetic Vision, Panning Timeout

## 1.7 NEAREST AIRPORT CRITERIA SETTINGS

The Nearest Airports Option Menu allows the pilot to filter out airports that do not meet a defined criteria. Specific surface types and runway lengths can be defined, as well as the option to include private airports and/or heliports.

Runway Surface—allows you to set criteria for the type of surface on the runway:

- **Hard Only**—shows only runways with a concrete, asphalt, or similar sealed surface.
- **Hard or Soft**—shows all runways except water landing facilities.
- **Water Only**—shows only water landing facilities.
- **Any**—shows any runway, regardless of surface type, including water landing facilities.

Minimum Runway Length—allows the pilot to enter a specific length for the shortest runway allowed.

### Entering airport criteria:

- 1) From the **Main Menu**, touch **Nearest**.
- 2) Touch the dedicated page icon and touch **Airport**.
- 3) Touch **Menu**.
- 4) Touch **Surface**, and touch the desired runway surface from the list.
- 5) Touch **Min Length**, and enter the desired Minimum Runway Length using the keypad.
- 6) Touch **Private Airports** to include Private Airports in the search.
- 7) Touch **Heliports** to include Heliports in the search.
- 8) Touch **City Names** or **Facility Names** to display the airport's city or facility name.

# 1.8 PRESENT POSITION

The Present Position function displays latitude, longitude, GPS altitude, reference waypoint, type, distance, direction, and bearing. The reference waypoint is designed to display the current position in relation to a prominent landmark. The pilot can change the reference waypoint 'Nearest Type' using the 'Change Nearest Type' menu option. By default the Nearest Type is set to 'Automatic', which will display the nearest large airport, enroute VOR, or city (in that order).



Position

### Changing the Nearest Type:

- 1) From the **Main Menu**, touch **GPS Info** > **Position Tab** > **Menu** > **Change Nearest Type**.
- 2) Touch the desired nearest type ('Automatic', 'Airport', 'VOR', 'NDB', 'Intersection', 'City', or 'Waypoint').

### Viewing the present position:

From the **Main Menu**, touch **GPS Info** > **Position Tab**.

## 1.9 NEW LOCATION

The 'New Location' menu option is used when the GPS Receiver is having trouble finding the satellites it expects to be there.

### Entering a new location:

- 1) From the **Main Menu**, touch **GPS Info** > **GPS Tab** > **Menu** > **New Location**.
- 2) Touch '**Automatic**', '**Use Map**', or '**Use Identifier**'.
- 3) After selecting your approximate position using the map pointer or entering an identifier, touch **OK**.
- 4) The GPS Receiver will begin a new search based on the location entered.

## 1.10 SIMULATOR MODE

Simulator Mode is helpful for practicing with the unit indoors or when no satellite signals are available. All waypoints and routes created in Simulator Mode are retained in memory for future use.



---

**NOTE:** Do not attempt to navigate using Simulator Mode. When the unit is set to Simulator Mode, the GPS/GLONASS receiver is turned off. Any Satellite Signal Strength Bars shown are only simulations and do not represent the strength of actual satellite signals.

---

### Starting/Stopping Simulator Mode:

From the **Main Menu**, touch **GPS Info** > **GPS Tab** > **Menu** > **Start/Stop Simulator**.

### Adjusting the simulated altitude, track, speed, waypoint, & position:

- 1) From the **Main Menu**, touch **GPS Info** > **GPS Tab** > **Menu** > **Start Simulator**.
- 2) Touch **Menu** > **Drive Simulator**.
- 3) Touch the fields to enter the desired data using the keypad.



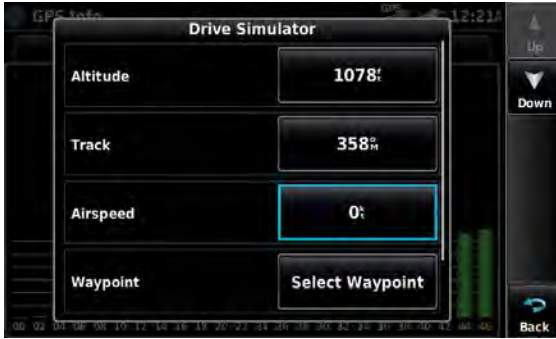

Simulator Mode

Blank Page

# SECTION 2 NAVIGATION

## 2.1 INTRODUCTION

The Navigation Map displays aviation data (e.g., airports, VORs, airways, airspaces), geographic data (e.g., cities, lakes, highways, borders), and topographic data (map shading indicating elevation). The Navigation Map can be oriented three different ways: North Up (NORTH UP), Track Up (TRK UP) or Desired Track Up (DTK UP).

An aircraft icon is placed on the Navigation Map at the location corresponding to the calculated present position. The aircraft position and the flight plan legs are accurately based on GPS/GLONASS calculations. The basemap upon which these are placed are from a source with less resolution, therefore the relative position of the aircraft to map features is not exact. The leg of the active flight plan currently being flown is shown as a magenta line on the navigation map. The other legs are shown in white.

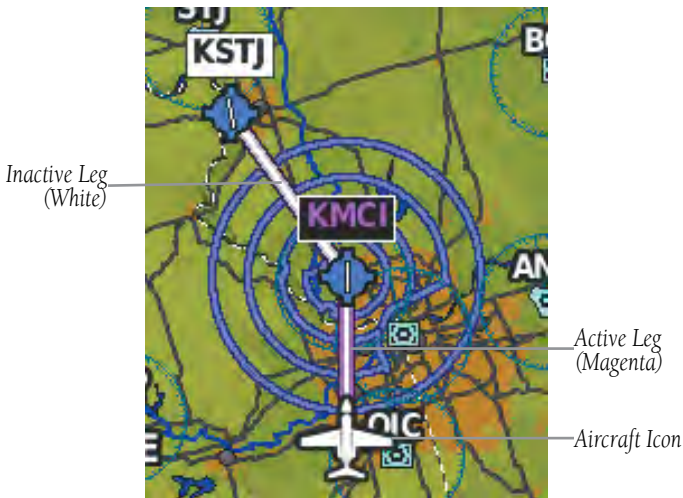

**Flight Plan Legs (Navigation Map)**

## DATA FIELDS

The data fields on the Navigation Map can be independently configured by the user.

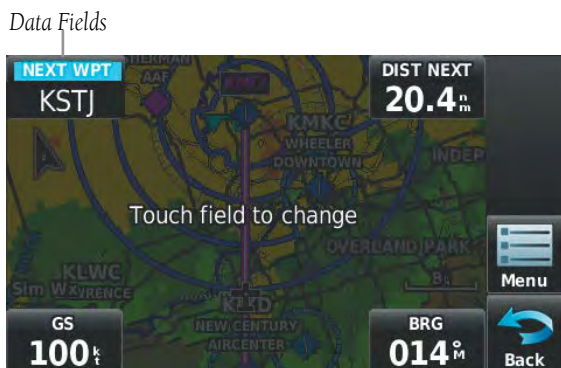

Data Fields (Navigation Map)

By default, the Data Bar Fields are set to display Ground Speed (GS), Distance - Next (DIST NEXT), Vertical Speed Required (VSR), and Time En Route - Next (ETE NEXT). These four data fields can be changed to display any of the Data Field Options.

### Changing the information shown in the data fields:

- 1) From the **Main Menu**, touch **Map** > **Menu** > **Change Data Fields**
- 2) Touch the desired Data Field to change. A list of available Data Field Options is displayed.
- 3) Touch the desired Data Field Option.

## DATA FIELD OPTIONS

- Accuracy
- Altitude
- Bearing (BRG)
- Course to Steer (CTS)
- Crosstrack Error (XTK)
- Desired Track (DTK)
- Distance (Destination) (DIST DEST)
- Distance (Next) (DIST NEXT)
- En Route Safe Altitude (ESA)
- External Voltage (EXT VOLTS)
- Flight Timer (FLT TIMER)
- Fuel Timer
- Glide Ratio (G/R)
- Ground Speed (GS)
- Ground Track (TRK)
- Minimum Safe Altitude (MSA)
- Next Waypoint (NEXT WPT)
- Sunrise
- Sunset
- Time En Route (Destination) (ETE DEST)
- Time En Route (Next) (ETE NEXT)
- Time of Arrival (Destination) (ETA DEST)
- Time of Arrival (NEXT) (ETA NEXT)
- Time to VNAV (VNAV TIME)
- Time (Local)
- Time (UTC)
- Vertical Speed (VS)
- Vertical Speed Required (VSR)
- Wx (Altimeter) (WX ALTIM)
- Wx (Dew Point) (WX DEW PT)
- Wx (Rel. Humidity) (WX HUMIDITY)
- Wx (Temperature) (WX TEMP)
- Wx (Wind) (WX WIND)

## COMPASS ARC

A compass arc appears by default on the Navigation Map. The magenta bug indicator (similar to the bug indicator on the HSI) can be set by touching **TRK** on the 3D Vision Page.

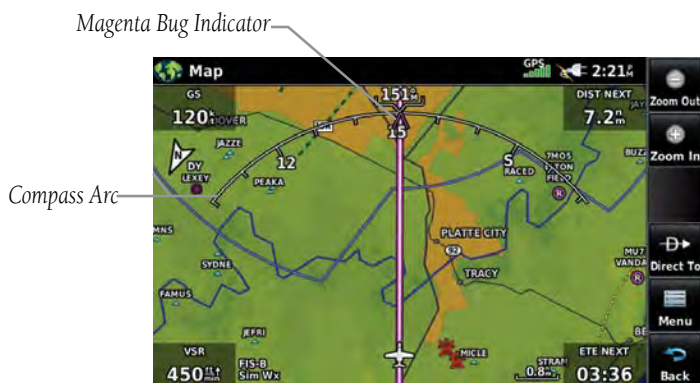

Compass Arc (Navigation Map)

### Displaying/Removing the Compass Arc on the Navigation Map:

- 1) From the **Main Menu**, touch **Map** > **Menu** > **Set Up Map**
- 2) Touch the dedicated page icon, and touch **General**.
- 3) Touch **On** or **Off** to display or remove the Compass Arc.

## 2.2 3D VISION

3D Vision provides a three-dimensional view of terrain features as seen from outside the aircraft. 3D Vision imagery shows the relevant features in relation to the aircraft.



**WARNING:** Use appropriate systems for navigation, and for terrain, obstacle, and traffic avoidance. 3D Vision does not provide either the accuracy or reliability upon which to base decisions and/or plan maneuvers to avoid terrain, obstacles, or traffic.

3D Vision is a visual enhancement to the aera 660. 3D Vision depicts the topography as seen from outside the aircraft. The depicted imagery is derived from the aircraft's three-dimensional position, and databases of terrain, obstacles, and other relevant features. Loss of the GPS signal, will cause 3D Vision to be disabled until it is restored.

The 3D Vision terrain display shows land contours (colors are consistent with those of the topographical map display), large water features, towers, and other obstacles over 200' AGL that are included in the obstacle database (if present). Cultural features on the ground such as roads, highways, railroad tracks, cities, and state boundaries are not displayed even if those features are found on the Navigation Map. The terrain display also includes a north-south east-west grid with lines oriented with true north.

Terrain is integrated within 3D Vision to provide visual and auditory alerts to indicate the presence of terrain and obstacle threats relevant to the projected flight path. Terrain alerts are displayed in red and yellow shading.

3D Vision does not provide the accuracy or fidelity on which to base decisions and plan maneuvers to avoid terrain or obstacles. Navigation should not be predicated upon the use of the terrain or obstacle data displayed by 3D Vision.

Touch and drag the three-dimensional view to change the perspective.



3D Vision (Tapes)



3D Vision (Round Gauges)

## 3D VISION OPERATION

3D Vision is accessed from the **Main Menu**.

### Viewing 3D Vision:

From the **Main Menu**, touch **3D Vision**

### Display instrument tapes or round gauges:

From the **Main Menu**, touch **3D Vision** > **Menu** > **Tapes** or **Round Gauges**.

### Changing the Bearing Pointers:

- 1) From the **Main Menu**, touch **3D Vision** > **Menu**
- 2) Touch a '**Bearing Pointer**' Data Option Button, and touch the desired option from the list (**Off**, **GPS**, or **Nearest Airport**).



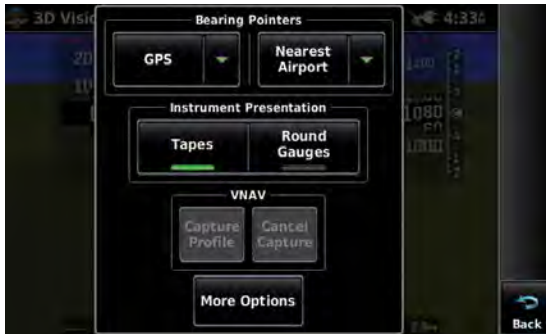

3D Vision Menu

## HORIZONTAL SITUATION INDICATOR (HSI)

The graphic HSI depicts the course to the destination or the next waypoint in a flight plan, current ground track, off course error, and a To/From indication. The rotating compass indicates the aircraft's current ground track.

The course pointer and course deviation needle indicate the course and whether the aircraft is on the course. The Bug Indicator can be set to 'Bearing' (default), 'Desired Track', a specific heading reference ('User Selected'), or 'Off'.

Bearing is the compass direction from the present position to a destination waypoint. Desired Track is the recommended direction to steer in order to reduce cross-track error and return to the course line.

The Course Deviation Indicator, or needle, indicates how far off course, left or right, based on its placement along the course deviation scale.

The course deviation scale setting is adjustable for Auto,  $\pm 0.25$ , 1.25 or 5.0 (nautical mile, statute mile, or kilometer) full-scale deflection. The course deviation scale appears on the upper right corner of the HSI. The default setting is Auto, which uses three factors to determine the distance from the center of the CDI to full left or right limits:

- CDI scale = 1.25 - within 30 nm of any airport in the active route.
- CDI scale = 0.25 - on an approach leg or within 2 nm of the FAF or MAP.
- CDI scale = 5.0 - if the previous two conditions do not exist.

## CHANGING THE CDI SCALE

### Changing the CDI scale:

- 1) From the **Main Menu**, touch **3D Vision** > **Menu** > **More Options**.
- 2) Touch the '**CDI Scale**' Data Option Button, and touch the desired option from the list (**0.25 nm**, **1.25 nm**, or **5.00nm**).

## SETTING THE BUG INDICATOR

The Bug Indicator can be set from the 3D Vision option menu.

### Setting the 3D Vision Bug Indicator:

- 1) From the **Main Menu**, touch **3D Vision** > **Menu** > **More Options**.
- 2) Touch the '**Bug Indicator**' Data Option Button, and touch the desired option from the list (**User Selected**, **Bearing**, **Desired Track**, or **Off**).

## MANUALLY SETTING A COURSE

Touch '**CRS**' on the 3D Vision Page to manually set a course to the destination.

### Manually setting a course to the destination waypoint:

- 1) From the **Main Menu**, touch **3D Vision**.
- 2) Touch **CRS**.
- 3) Touch **YES** when the 'Set OBS and hold?' window appears (only available when navigating a Direct To or Flight Plan).
- 4) Select a course using the keypad and touch **Enter**.

### Returning to automatic sequencing of route waypoints:

- 1) From the **Main Menu**, touch **3D Vision**.
- 2) Touch **CRS**.
- 3) Touch **Release OBS Hold** (only available when navigating a Direct To or Flight Plan).

## 2.3 VERTICAL NAVIGATION (VNAV)

The VNAV function provides settings for the vertical navigation. These settings create a three-dimensional profile from the present location and altitude to a final (target) altitude at a specified location.

When the VNAV profile is defined, the pilot is informed of the progress by message alerts. The teal bar on the HSI (when displayed) shows the VNAV profile.

The Vertical Navigation feature is only available when navigating a Direct To or flight plan, and the ground speed is greater than 35 knots.

The “Approaching VNAV Profile” message appears one minute prior to the initial descent point. The descent angle locks to prevent changes in speed from altering the profile. The VNAV feature does not take into account any changes in groundspeed that occur during the transition from level flight to descent or climb.

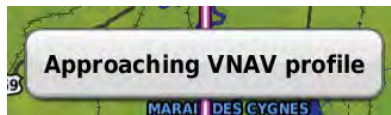

At 500 ft above the target altitude, the “Approaching Target Altitude” message appears, the ‘Estimated Time To VNAV’ goes blank, and the VNAV indicator disappears from the HSI.



**CAUTION:** The aera is a VFR navigation tool and should not be used to perform instrument approaches.



**CAUTION:** VNAV is only a VFR navigation aid and is not intended for instrument approaches.

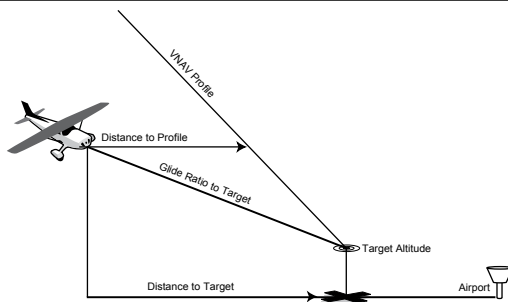

**Visual Representation of VNAV**

## USING THE VNAV FEATURE

Use the VNAV (Vertical Navigation) feature to ensure the aircraft is at the proper altitude. The VNAV Indicator appears Altimeter (when displayed) as a teal pointer. A message appears when approaching the VNAV Profile. When the teal pointer is in the vertical center of the altimeter, the aircraft is at the proper altitude for the VNAV Profile.

### Capturing/cancelling VNAV profile:

- 1) While navigating a Direct To or Flight Plan, from the **Main Menu**, touch **3D Vision** > **Menu**.
- 2) Touch **Capture Profile** or **Cancel Capture**.



VNAV Indicator (3D Vision)

**Configuring a VNAV profile:**

- 1) From the **Main Menu**, touch **Tools > VNAV**
- 2) Touch the desired fields ('**Waypoint**', '**Profile**', '**Altitude**', etc) to enter the VNAV profile.
- 3) Touch and hold the **Back** Icon to return to the **Main Menu**.



**Vertical Navigation Configuration**

- **Waypoint**—Enter any waypoint along the currently active route as the reference waypoint. The reference waypoint defines the target location.
- **Profile**—Enter the descent rate.
- **Altitude**—Enter the desired reference waypoint altitude. Select 'Above Waypoint' to use field elevation for airports in the Jeppesen database or 'MSL' to specify an exact MSL altitude target.
- **By**—Enter the target location with settings of distance 'Before' or 'After' a reference waypoint. To set a target location at a reference waypoint, enter a distance of zero.
- **VNAV Messages**—Touch 'On' or 'Off' to enable/disable VNAV alert messages.

## 2.4 MAP DISPLAY SETUP

Map displays are used extensively in the aera to provide situational awareness in flight. Most aera maps can display the following information:

- Airports, NAVAIDs, airspaces, airways, land data (highways, cities, lakes, rivers, borders, etc.) with names
- Map Pointer information (distance and bearing to pointer, location of pointer, name, and other pertinent information)
- Map range
- Aircraft icon (representing present position)
- Flight plan legs
- User waypoints
- Track vector
- Topography data

### MAP ORIENTATION

Maps are shown in one of three different orientation options, allowing flexibility in determining aircraft position relative to other items on the map (North Up), or for determining where map items are relative to where the aircraft is going (Track Up), or desired track up (DTK UP)).

- North Up aligns the top of the map display to north (default setting).
- Track Up aligns the top of the map display to the current ground track.
- Desired Track (DTK) Up aligns the top of the map display to the desired course.



**NOTE:** Map orientation can only be changed from the Navigation Map Option Menu. All other maps (except weather maps) that show navigation data reflect the orientation selected for the Navigation Map.

**Adjusting the map orientation:**

- 1) From the **Main Menu**, touch **Map > Menu > Set Up Map**.
- 2) If necessary, touch the Dedicated Page Icon, and touch the **General** Group.
- 3) Touch the '**Orientation**' Data Option Button, and touch the desired option from the list (**North Up**, **Track Up**, or **DTK Up**).

**AIRPORTS, NAVAIDS, CITIES & ROADS**

**Setting up and customizing airports, NAVAIDs, cities & roads for the navigation map:**

- 1) From the **Main Menu**, touch **Map > Menu > Set Up Map**.
- 2) Touch the Dedicated Page Icon, and touch the '**Airport**', '**Navaid**', '**City**', or '**Road**' Group.
- 3) Touch  to select the desired settings.



**Map Setup (Cities)**

*Dedicated Page Icon*

## AIRWAYS

Low Altitude Airways (or Victor Airways) primarily serve smaller piston-engine, propeller-driven airplanes on shorter routes and at lower altitudes. Airways are eight nautical miles wide and start 1,200 feet above ground level (AGL) and extend up to but not including 18,000 feet mean sea level (MSL). Low Altitude Airways are designated with a "V" before the airway number (hence the name "Victor Airways") since they run primarily between VORs.

High Altitude Airways (or Jet Routes) primarily serve airliners, jets, turboprops, and turbocharged piston aircraft operating above 18,000 feet MSL. Jet Routes start at 18,000 feet MSL and extend upward to 45,000 feet MSL (altitudes above 18,000 feet are called "flight levels" and are described as FL450 for 45,000 feet MSL). Jet Routes are designated with a "J" before the route number.

Low Altitude Airways are drawn in gray. High Altitude Airways are drawn in green. When both types of airways are displayed, high altitude airways are drawn on top of Low Altitude Airways.

When airways are selected for display on the map, the airway waypoints (VORs, NDBs and Intersections) are also displayed.

### Displaying/removing airways:

- 1) From the **Main Menu**, touch **Map > Menu > Set Up Map**.
- 2) If necessary, touch the Dedicated Page Icon, and touch the **Navaid** Group.
- 3) Touch the '**Airways**' Data Option Button, and touch the desired option from the list ('**Off**', '**Low**', '**High**', or '**Both**').



## 2.5 WAYPOINTS

The WPT INFO (Waypoint Information) function provides airport and waypoint information.

Waypoints are predetermined geographical positions (internal database) or pilot-entered positions, and are used for all phases of flight planning and navigation.

Waypoints can be selected by entering the ICAO identifier, entering the name of the facility, or by entering the city name. As a waypoint identifier, facility name, or location is entered, the aera's Spell'N'Find™ feature scrolls through the database, displaying those waypoints matching the characters which have been entered up to that point. A direct-to navigation leg to the selected waypoint can be initiated by pressing the **►** Icon.

The waypoint function allows the pilot to review airport information, runway information, frequencies, AOPA information (if available), and weather information (if available) by touching the desired tab. The pilot can manually enter the identifier or the aera will choose the most appropriate identifier based on the current position and phase of flight.



The following descriptions and abbreviations are used:

- Usage type: Public, Military, or Private
- Runway surface type: Hard, Turf, Sealed, Gravel, Dirt, Soft, Unknown, or Water

- Runway lighting type: No Lights, Part Time, Full Time, Unknown, or PCL Freq (for pilot-controlled lighting)
- COM Availability: TX (transmit only), RX (receive only), PT (part time), \* (additional information available)

### Selecting an airport for review by identifier, facility name, or city:

- 1) From the **Main Menu**, touch **Waypoint** > **Info** Tab (if necessary).
- 2) Touch the Waypoint Identifier Button.
- 3) Enter the desired waypoint using the keypad and touch **Enter**.

**Or:**

- a) Touch **Find**.
- b) Touch the **Search Name** or **Search City** Tab.
- c) Touch the **Search by Facility Name** or **Search by City** button.
- d) Enter the facility name or city using the keypad and touch **Enter**.

**Or:**

- a) Touch **Find**.
  - b) Touch the **Recent**, **Nearest Airports**, **Flight Plan**, or **User** Tab.
  - c) Touch the desired waypoint from the list.
- 4) If duplicate entries exist for the entered facility name or location, duplicate waypoints are displayed. Touch the desired waypoint from the list.

### Selecting a runway:

- 1) From the **Main Menu**, touch **Waypoint** > **Runway** Tab (if necessary).
- 2) Touch the Waypoint Identifier Button.
- 3) Enter the desired waypoint using the keypad and touch **Enter**.

**Or:**

- a) Touch **Find**.
- b) Touch the **Search Name** or **Search City** Tab.
- c) Touch the **Search by Facility Name** or **Search by City** button.
- d) Enter the facility name or city using the keypad and touch **Enter**.

**Or:**

- a) Touch **Find**.
  - b) Touch the **Recent, Nearest Airports, Flight Plan, or User** Tab.
  - c) Touch the desired waypoint from the list.
- 4) If duplicate entries exist for the entered facility name or location, duplicate waypoints are displayed. Touch the desired waypoint from the list.
  - 5) If multiple runways exist, touch the Runway Button, and touch the desired runway from the vertical list.



Waypoint Information (Runway Tab)

### Selecting additional information for a frequency:

- 1) From the **Main Menu**, touch **Waypoint > Freq** Tab (if necessary).
- 2) Touch .



Waypoint Information (Freq Tab)

The Frequencies Box uses the descriptions and abbreviations listed in the following table:

Communication Frequencies			Navigation Frequencies
Approach *	Control	Pre-Taxi	ILS
Arrival *	CTA *	Radar	LOC
ASOS	Departure *	Ramp	
ATIS	Gate	Terminal*	
AWOS	Ground	TMA *	
Center	Helicopter	Tower	
Class B *	Multicom	TRSA *	
Class C *	Other	Unicom	
Clearance			
* May include Additional Information			

Frequency Abbreviations

## NEAREST INFORMATION

The aera provides a Nearest function which gives the pilot quick access to nearest airport, weather, VOR, NDB, intersection, user waypoint, city, ARTCC, FSS, and airspace information. If there are none available, "None Within 200 NM" is displayed.

The Nearest functions contain the following information.

- Airport—identifier, bearing, distance, length of the longest runway, and common traffic advisory (CTAF) or tower frequency.
- Airport WX (Airport Weather)—identifier, bearing, distance, METAR text, and ATIS, AWOS, or ASOS frequency.
- VOR (VHF Omnidirectional Radio Beacon)—identifier, facility type (symbol), bearing, distance, and frequency.
- NDB (Non Directional Beacons)—identifier, facility, type (symbol), bearing, distance, and frequency.
- Intersection—identifier, bearing, and distance.

- VRP (Visual Reporting Point) (Atlantic Unit Only)—identifier, bearing, and distance.
- USR WPT (User Waypoints)—name, bearing, and distance.
- City—name, bearing, and distance.
- ARTCC (Air Route Traffic Control Center)—bearing, distance, and frequency.
- FSS (Flight Service Station)—name, bearing, distance, frequency, and VOR (if applicable).
- Airspace—name, time to entry (when applicable), and status.

### Viewing nearest information:

- 1) From the **Main Menu**, touch **Nearest**.
- 2) Touch the Dedicated Page Icon, and touch the desired Nearest Icon (**Airport**, **Apt WX**, **VOR**, **NDB**, **INT**, **User WPT**, **City**, **ARTCC**, **FSS**, or **Airspace**).
- 3) Touch the desired nearest option from the list for additional information.

**Or:**

If viewing Nearest ARTCCs or FSSs, touch **Multiple Freqs...** to view additional frequencies.

- 4) Touch the **Back** Icon to return to the previous page.



Nearest VORs List



Additional VOR Information

## NEAREST AIRPORT CRITERIA

The pilot can define the minimum runway length and surface type used when determining the 15 nearest airports to display. A minimum runway length and/or surface type can be entered to prevent airports with small runways or runways that are not appropriately surfaced from being displayed. Default settings are 0 feet (or meters) for runway length and "Any" for runway surface type. Private airports and Heliports can also be included.

The Nearest Airports Option Menu also allows the pilot to choose between displaying the facility names, city names, bearing, or direction arrows.

### Setting nearest airport criteria:

Refer to Section 1.7 'Airport Criteria Settings'.

## WEATHER AND NOTAM INFORMATION (OPTIONAL)

Textual weather and NOTAM information can be viewed several different ways.

### Viewing airport weather/NOTAM information:

- 1) From the **Main Menu**, touch **Waypoint**.
  - 2) Enter the desired waypoint identifier.
  - 3) Touch the **Weather** or **NOTAM** Tab.
- Or:**
- 1) From the **Main Menu**, touch **Nearest**.
  - 2) Touch the Dedicated Page Icon, and touch **Apt WX**.
  - 3) Touch the desired Nearest Airport Weather from the list.

**Or:**

- 1) From the **Main Menu**, touch the **Weather**.
- 2) Touch the Dedicated Page Icon, and touch **METAR**.
- 3) Touch the desired METAR flag.
- 4) Touch the Map Feature Button with the desired identifier displayed (refer to 'Map Panning' in the Overview Section for more information). The weather information is displayed.

**Or:**

- 1) From the **Main Menu**, touch the **Map** Icon.
- 2) Touch the desired METAR Flag (If the METAR flags are not displayed, adjust the settings from the 'Set Up Map' menu option).
- 3) Touch the Map Feature Button with the desired identifier displayed (refer to 'Map Panning' in the Overview Section for more information). The weather information is displayed.

*METAR Selected*

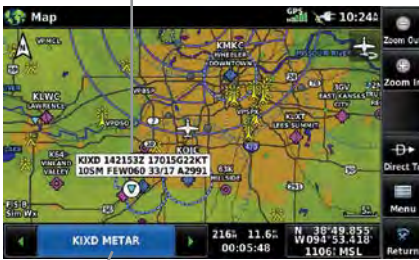

*Map  
Feature  
Button*



**Weather Information**

## ACCESSING ADDITIONAL INFORMATION

In addition to airport and weather information, additional information for VORs, NDBs, Intersections, User Waypoints, Cities, ARTCCs, FSSs, and Airspace can be viewed using the Waypoint Information function, the Nearest function, or the Map Panning function.

Additional Information									
	Airport	VOR	NDB	Intersection	User Wpt	City	ARTCC	FSS	Airspace
Identifier	+	+	+	+	+				
Frequency	+	+	+				+	+	+
Name	+	+	+	+	+				+
City	+	+	+			+			+
State	+	+	+			+			
Type	+	+	+						
Morse Code		+	+						
Radial		+							
Region	+	+	+	+	+				
Bearing	+	+	+	+	+	+	+	+	
Distance	+	+	+	+	+	+	+	+	+
Lat/Long	+	+	+	+	+	+			
Elevation (MSL)	+				+				
Fuel Available	+								
Time Zone (UTC Offset)	+								
Runway Information	+								
AOPA	+								
Weather	+								
Controlling Agency									+
Vertical Boundaries									+
Class									+



## INTERSECTIONS

Intersection information can be viewed using the Waypoint Information function, the Nearest function, or the Map Panning function.

The Nearest Intersection function can be used to quickly find an intersection close to the flight path. The list only includes Intersections that are within 200nm. If there are no Intersections within the range, text indicating that there are no nearest intersections is displayed.

### Select an intersection:

- 1) From the **Main Menu**, touch **Waypoint**.
- 2) Touch the Waypoint Identifier Field to begin entering the desired intersection. Refer to the Overview Section on 'Data Entry' for more information.

#### Or:

- 1) From the **Main Menu**, touch **Nearest**.
- 2) Touch the Dedicated Page Icon, and touch **INT**.
- 3) Touch the desired intersection from the list.

#### Or:

- 1) From the **Main Menu**, touch **Map**.
- 2) Touch the desired Intersection on the map.
- 3) Touch the Map Feature Button with the desired intersection displayed (refer to the Overview Section on 'Map Panning' for more information). The intersection information is displayed.

## NDBs

NDB information can be viewed using the Waypoint Information function, the Nearest function, or the Map Panning function.

The Nearest NDB function can be used to quickly find a NDB close to the flight path. The list only includes NDBs that are within 200nm. If there are no NDBs in the list, text indicating that there are no nearest NDBs is displayed.

**Select an NDB:**

- 1) From the **Main Menu**, touch **Waypoint**.
- 2) Touch the Waypoint Identifier Field to begin entering the desired NDB. Refer to the Overview Section on 'Data Entry' for more information.

**Or:**

- 1) From the **Main Menu**, touch **Nearest**.
- 2) Touch the Dedicated Page Icon, and touch **NDB**.
- 3) Touch the desired NDB from the list.

**Or:**

- 1) From the **Main Menu**, touch **Map**.
- 2) Touch the desired NDB on the map.
- 3) Touch the Map Feature Button with the desired NDB displayed (refer to the Overview Section on 'Map Panning' for more information). The intersection information is displayed.

**VORs**

VOR information can be viewed using the Waypoint Information function, the Nearest function, or the Map Panning function.

The Nearest VOR function can be used to quickly find a VOR close to the flight path. The list only includes VORs that are within 200nm. If there are no VORs in the list, text indicating that there are no nearest VORs is displayed.

Localizer information cannot be viewed for the VOR. If a VOR station is combined with a TACAN station it is listed as a VORTAC, and if it includes only DME it is displayed as VOR-DME.

**Select an VOR:**

- 1) From the **Main Menu**, touch **Waypoint**.
- 2) Touch the Waypoint Identifier Field to begin entering the desired VOR. Refer to the Overview Section on 'Data Entry' for more information.

**Or:**

- 1) From the **Main Menu**, touch **Nearest**.
- 2) Touch the Dedicated Page Icon, and touch **VOR**.
- 3) Touch the desired VOR from the list.

**Or:**

- 1) From the **Main Menu**, touch **Map**.
- 2) Touch the desired VOR on the map.
- 3) Touch the Map Feature Button with the desired VOR displayed (refer to the Overview Section on 'Map Panning' for more information). The intersection information is displayed.

## USER WAYPOINTS

The aera can create and store up to 3,000 user-defined waypoints. Once a waypoint has been created, it can be renamed, deleted, or moved.

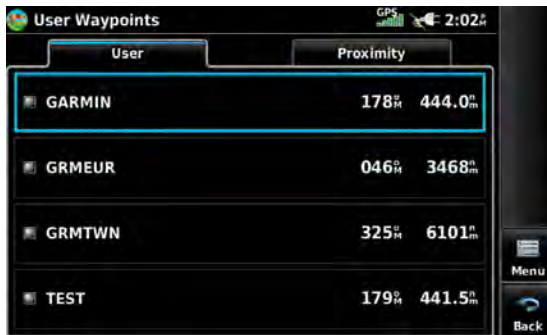

User Waypoints

### Creating user waypoints:

- 1) To create a new user waypoint at the current location or using the Map Pointer:
    - a) From the **Main Menu**, touch **Tools > User Waypoints > Menu**.
    - b) Touch **Create Waypoint**.
- Or:**
- a) With a map displayed, touch an empty area without any map features.
  - b) Touch the Map Feature Button.
  - c) Touch **Save**.
- Or:**

a) From the **Main Menu**, touch **GPS Info** > **Position Tab** > **Menu**.

b) Touch **Mark Waypoint**.

2) Enter the desired user waypoint name (up to 10 characters) and touch **Enter**. Refer to the Overview Section on 'Data Entry' for more information.

3) If changing the User Waypoint settings (symbol, altitude, location, or reference waypoints) continue with Step 4.

4) If desired, touch the **Symbol** Field to change the symbol that will appear on the map.

a) Touch the desired symbol.

b) Touch **OK**.

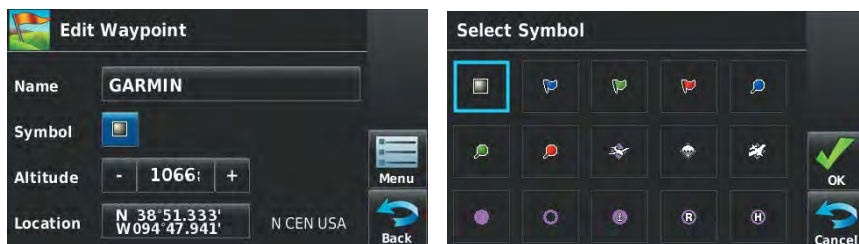

### User Waypoint Symbols

5) If desired, touch the **Altitude** Field

a) Enter the desired altitude using the keypad or the +/- buttons. Refer to the Overview Section on 'Data Entry' for more information.

b) Touch **Enter**.

6) If desired, touch the **Location** Field.

a) Enter the desired latitude and longitude by touching the left/right arrows to move the cursor, and the up/down arrows to change the value.

b) Touch **Enter**.



**User Waypoint Location**

- 7) If desired, touch the **Menu Icon** and touch 'Reference Waypoints' to enter a bearing and distance from another waypoint or the bearing from two other waypoints to define a new waypoint location.
  - a) Touch the **Waypoint Field(s)** to enter the desired waypoint.
  - b) Touch the **Bearing** and/or **Distance** Fields to enter the desired values.
  - c) Touch **OK**.

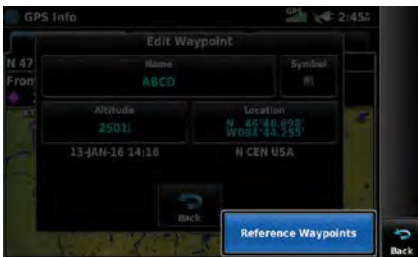

**Reference Waypoints**

**Selecting and viewing nearest user waypoints:**

- 1) From the **Main Menu**, touch **Nearest**.
- 2) Touch the Dedicated Page Icon, and touch **User WPT**.
- 3) Touch the desired User Waypoint. The User Waypoint information is displayed.

**Editing or renaming a user waypoint:**

- 1) From the **Main Menu**, touch **Tools > User Waypoints > User Tab**.
- 2) Touch the desired User Waypoint. The option menu automatically displays.
- 3) Touch **Edit Waypoint**.

- 4) Touch the desired field to edit:
  - a) Touch the **Name** Button.
  - b) Enter the desired user waypoint name (up to 10 characters). Refer to the Overview Section on 'Data Entry' for more information.

**Or:**

- a) Touch the **Symbol** Button.
- b) Touch the desired symbol.

**Or:**

- a) Touch the **Altitude** Button.
- b) Enter the desired altitude. Refer to the Overview Section on 'Data Entry' for more information.

**Or:**

- a) Touch the **Location** Button.
- b) Enter the desired latitude and longitude by touching the left/right arrows to move the cursor, and the up/down arrows to change the value.

- 5) Touch **Enter**.

### Deleting user waypoints:

- 1) From the **Main Menu**, touch **Tools** > **User Waypoints** > **User** Tab.
- 2) Delete a single waypoint, delete all waypoints, delete by symbol or delete by distance:
  - a) Touch the desired User Waypoint. The option menu automatically displays
  - b) Touch the '**Delete Waypoint**' menu option. The confirmation window will appear.

**Or:**

  - a) Touch the **Menu** Icon.
  - b) Touch the '**Delete All**' menu option. The confirmation window will appear.

**Or:**

  - a) Touch the **Menu** Icon.
  - b) Touch the '**Delete by Symbol**' menu option.

- c) Touch the desired symbol to delete. The symbol will be highlighted blue.
  - d) Touch the **OK** icon. The confirmation window will appear.
- Or:**
- a) Touch the **Menu** Icon.
  - b) Touch the '**Delete by Distance**' menu option.
  - c) If desired, touch the **From** Field and touch '**Current Location**' (default), '**Use Identifier**', or '**Use Map**' from the option menu.
  - d) If desired, touch the '**Less Than/More Than**' Button, and touch the **Distance** Field to enter the desired distance.
  - e) Touch the **OK** icon. The confirmation window will appear.
- 3) Touch **Yes**.

## CITIES

City information can be viewed using the Waypoint Information function, the Nearest function, or the Map Panning function.

The Nearest City function can be used to quickly find a city close to the flight path. The list only includes cities that are within 200nm. If there are no cities in the list, text indicating that there are no nearest cities is displayed.

### Select a city:

- 1) From the **Main Menu**, touch **Waypoint** > **Info** Tab.
- 2) Touch the Waypoint Identifier Field.
- 3) Touch **Find** > **Search City** Tab > **Search by City**.
- 4) Enter the desired city using the keypad and touch **Enter**. Refer to the Overview Section on 'Data Entry' for more information.

**Or:**

- 1) From the **Main Menu**, touch **Nearest**.
- 2) Touch the Dedicated Page Icon, and touch **City**.
- 3) Touch the desired Nearest City from the list.

**Or:**

- 1) From the **Main Menu**, touch **Map**.

- 2) Touch the desired city symbol on the map.
- 3) Touch the Map Feature Button with the desired city displayed (refer to the Overview Section on 'Map Panning' for more information). The city information is displayed.

## ARTCC

ARTCC information can be viewed using the Nearest function.

The Nearest ARTCC function can be used to quickly find a ARTCC close to the flight path. The list only includes ARTCC that are within 200nm. If there are no ARTCCs in the list, text indicating that there are no nearest ARTCCs is displayed.

### Select an ARTCC:

- 1) From the **Main Menu**, touch **Nearest**.
- 2) Touch the Dedicated Page Icon, and touch **ARTCC**.

## FSS

FSS information can be viewed using the Nearest function.

The Nearest FSS function can be used to quickly find a FSS close to the flight path. The list only includes FSS that are within 200nm. If there are no FSSs in the list, text indicating that there are no nearest FSSs is displayed.

### Select an FSS:

- 1) From the **Main Menu**, touch **Nearest**.
- 2) Touch the Dedicated Page Icon, and touch **FSS**.

## AIRSPACE

The Nearest Airspace function and Airspace Alerts provide information about airspaces and the location of the aircraft in relationship to them. The Nearest Airspace function can be used to quickly find airspaces close to the flight path.

The Nearest Airspace function displays the class of airspace, controlling agency, vertical boundaries, and status.



**Selecting and viewing nearest airspaces:**

- 1) From the **Main Menu**, touch **Nearest**.
- 2) Touch the Dedicated Page Icon, and touch **Airspace**.
- 3) Touch the desired airspace from the list. The airspace information is displayed.
- 4) If desired, touch '**Frequencies**' to view frequencies associated with that airspace.

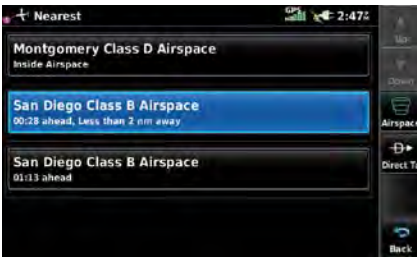

**Nearest Airspace**

**AIRSPACE ALERT MESSAGES**

If airspace alarms are set to 'On' (default is 'Off'), the aera will display a message which includes the airspace name, time to entry (if applicable), and status. Touch the message to acknowledge it.

There are four types of status information:

- Ahead—Projected to enter the airspace within the next 10 minutes or less
- Near—Within two nautical miles of an airspace but not projected to enter it.
- Near & Ahead—Project to enter the airspace within two nautical miles.
- Inside Airspace—Within the boundaries of the airspace.

## Airspace alert setup:

- 1) From the **Main Menu**, touch **Tools > Setup > Airspace**.
- 2) Touch the desired **On/Off** Button(s).



Airspace Alert Message

## SMART AIRSPACE™

Smart Airspace shows airspace at and immediately surrounding the aircraft's current altitude in bold. Airspaces at all other altitudes are de-emphasized.

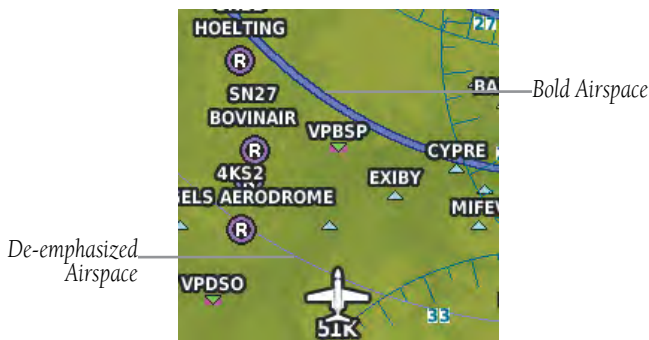

Smart Airspace™

## Smart Airspace setup:

- 1) From the **Main Menu**, touch **Map > Menu > Set Up Map**.
- 2) Touch the Dedicated Page Icon, and touch **Airspace**.
- 3) Touch the 'Smart Airspace' **On/Off** Button.

## 2.6 DIRECT-TO NAVIGATION

The Direct-to method of navigation, initiated by pressing the **Direct To** Icon is quicker to use than a flight plan when the desire is to navigate to a single point such as a nearby airport.



The **Direct To** Icon is available in the dedicated page icons on the right side of most pages.

Once a direct-to is activated, the aera establishes a point-to-point course line from the present position to the selected direct-to destination. Course guidance is provided until the direct-to is replaced with a new direct-to or flight plan, or cancelled.



Direct To

### Entering a direct-to destination:

- 1) When available, touch the **Direct To**  Icon.
  - 2) Touch the **Flight Plan**, **Nearest**, or **Recent** Tab.
  - 3) Touch the desired waypoint.
  - 4) Touch **Activate**.
- Or:**
- 1) When available, touch the **Direct To**  Icon.
  - 2) From the **Waypoint** Tab, touch **Select Waypoint**.
  - 3) Enter a waypoint identifier using the keypad and touch **Enter**.
- Or:**
- a) Touch **Find**.

- b) Touch the **Recent, Nearest Airports, Flight Plan, or User Tab**.
- c) Touch the desired waypoint.

**Or:**

- a) Touch **Find**.
- b) Touch the **Search Name Tab**.
- c) Touch **Search by Facility Name**.
- d) Enter the desired Facility Name using the keypad.

- e) Touch **Enter**.

**Or:**

- a) Touch **Find**.
- b) Touch the **Search City Tab**.
- c) Touch **Search by City**.
- d) Enter the desired City using the keypad.

- e) Touch **Enter**.

- 4) Touch **Activate**.

#### Selecting a nearby airport as a direct-to destination:

- 1) From the **Main Menu**, touch **Nearest**.
- 2) Touch the Dedicated Page Icon, and touch **Airport**.
- 3) Touch the desired nearest airport.
- 4) Touch **Direct To** ➤.
- 5) Touch **Activate**.

#### Selecting a waypoint as a direct-to destination using the pointer:

- 1) With a map displayed, activate the map pointer by touching the desired waypoint. If no airport, NAVAID, or User Waypoint exists at the desired location, a temporary waypoint named 'Map Pointer' is automatically created at the location of the map pointer.
- 2) Touch **Direct** ➤.
- 3) Touch **Activate**.

#### Cancelling a direct-to:

- 1) While navigating a Direct To Flight Plan, touch the **Direct To** ➤ Icon.
- 2) Touch **Stop Navigation**.

## SECTION 3 FLIGHT PLANNING

### 3.1 INTRODUCTION

Flight planning on the aera consists of building a flight plan by entering waypoints one at a time and inserting approaches as needed. The flight plan is displayed on maps using different line widths, colors, and types, based on the type of leg and the segment of the flight plan currently being flown.

Up to 50 flight plans with up to 300 waypoints each can be created and stored in memory. One flight plan can be activated at a time and becomes the active flight plan. The active flight plan is erased when the destination is reached and the system is turned off. When storing flight plans with an approach, the aera uses the waypoint information from the current database to define the waypoints. If the database is changed or updated, the aera automatically updates the information if the procedure has not been modified. If an approach is no longer available, the procedure is deleted from the affected stored flight plan(s), and an alert is displayed.

Whenever an approach is loaded into the active flight plan it replaces the destination airport with a sequence of waypoints for the selected approach. The airport must have a published instrument approach and only the final course segment (usually from final approach fix to missed approach point) of the published approach is available in the aera.

#### DATA FIELDS

The Active and Saved Flight Plan Data Fields can be changed by touching the Data Field Buttons at the top of the flight plan.

#### Changing the information shown in the flight plan data fields:

- 1) From the **Main Menu**, touch **Active Flight Plan**.
- Or:**
- a) From the **Main Menu**, touch **Flight Plan List**.
  - b) Touch the desired Saved Flight Plan from the list. An option menu appears.
  - c) Touch **Edit**.

- 2) Touch the desired Data Field Button at the top of the Flight Plan.
- 3) Touch to select the desired Data Field from the list. The currently selected Data Field is outlined blue.
- 4) If desired, repeat Steps 2-3 for the remaining Data Fields.

Data Field Button



Flight Plan Data Fields

## 3.2 FLIGHT PLAN CREATION

The active flight plan is the flight plan to which the aera is currently providing guidance, and is shown on the navigation maps. Stored flight plans are flight plans available for activation (becomes the active flight plan).

Data Fields



Active Flight Plan

## Creating an active flight plan:

- 1) From the **Main Menu**, touch **Active Flight Plan**.
- 2) Touch **Add Waypoint**.
- 3) Enter a waypoint identifier using the keypad and touch **Enter**.  
**Or:**
  - a) Touch **Find**.
  - b) Touch the **Recent, Nearest Airports, Flight Plan**, or **User** Tab.
  - c) Touch the desired waypoint.**Or:**
  - a) Touch **Find**.
  - b) Touch the **Search Name** Tab.
  - c) Touch **Search by Facility Name**.
  - d) Enter the desired Facility Name using the keypad.
  - e) Touch **Enter**.**Or:**
  - a) Touch **Find**.
  - b) Touch the **Search City** Tab.
  - c) Touch **Search by City**.
  - d) Enter the desired City using the keypad.
  - e) Touch **Enter**.
- 4) If duplicate entries exist for the entered facility name or location, duplicate waypoints are displayed. Touch the desired waypoint from the list.
- 5) Repeat Steps 2-4 to enter each additional waypoint.

## Creating a stored flight plan:

- 1) From the **Main Menu**, touch **Flight Plan List > Menu > New Flight Plan**.
- 2) Touch **Add Waypoint**.
- 3) Enter a waypoint identifier using the keypad and touch **Enter**.  
**Or:**
  - a) Touch **Find**.
  - b) Touch the **Recent, Nearest Airports, Flight Plan**, or **User** Tab.

c) Touch the desired waypoint.

**Or:**

a) Touch **Find**.

b) Touch the **Search Name** Tab.

c) Touch **Search by Facility Name**.

d) Enter the desired Facility Name using the keypad.

e) Touch **Enter**.

**Or:**

a) Touch **Find**.

b) Touch the **Search City** Tab.

c) Touch **Search by City**.

d) Enter the desired City using the keypad.

e) Touch **Enter**.

- 4) If duplicate entries exist for the entered facility name or location, duplicate waypoints are displayed. Touch the desired waypoint from the list.
- 5) Repeat Steps 2-4 to enter each additional waypoint.

## ADDING WAYPOINTS TO AN EXISTING FLIGHT PLAN

Waypoints can be added to the active flight plan or any stored flight plan. Choose the flight plan, select the desired point of insertion, enter the waypoint, and it is added in front of the selected waypoint. Flight plans are limited to 300 waypoints (including approach waypoints).

### Adding a waypoint to an active or stored flight plan:

- 1) With an active or saved flight plan displayed, touch the desired point of insertion. An option menu will appear.
- 2) Touch **Insert Before** or **Insert After**.
- 3) Enter a waypoint identifier using the keypad and touch **Enter**.

**Or:**

a) Touch **Find**.

b) Touch the **Recent, Nearest Airports, Flight Plan, or User** Tab.



- c) Touch the desired waypoint.
- Or:**
- a) Touch **Find**.
- b) Touch the **Search Name** Tab.
- c) Touch **Search by Facility Name**.
- d) Enter the desired Facility Name using the keypad.
- e) Touch **Enter**.
- Or:**
- a) Touch **Find**.
- b) Touch the **Search City** Tab.
- c) Touch **Search by City**.
- d) Enter the desired City using the keypad.
- e) Touch **Enter**.

- 4) If duplicate entries exist for the entered facility name or location, duplicate waypoints are displayed. Touch the desired waypoint from the list.

### Loading an approach procedure into a stored flight plan:

An Approach Procedure can be loaded at any airport that has an approach available. Only one approach can be loaded at a time in a flight plan. The route for a selected approach is defined by designating transition waypoints.

- 1) With an active or saved flight plan displayed, touch the **Menu** Icon
- 2) Touch **Select Approach**.
- 3) Touch  to display a list of approaches.
- 4) Touch the desired approach. The designated transition waypoints are added to the flight plan.
- 5) If desired, touch **Load Approach, Activate Approach, or Activate Vectors-to-Final**.

## 3.3 FLIGHT PLAN STORAGE

The aera can store up to 50 flight plans. The active flight plan is erased when another flight plan is activated. Details about each stored flight plan can be viewed using the Flight Plan List function.

### Viewing information about a stored flight plan:

- 1) From the **Main Menu**, touch **Flight Plan List**.
- 2) Touch the desired saved flight plan. An option menu is displayed.
- 3) Touch **Edit**.



Flight Plan List

### Storing an active flight plan:

- 1) With the Active Flight Plan displayed, touch **Menu**.
- 2) Touch **Save Copy**. A confirmation window appears.
- 3) Touch **Yes**. A copy of the flight plan is stored in the next available position in the Flight Plan List.

## 3.4 FLIGHT PLAN ACTIVATION

Activating a stored flight plan erases the active flight plan and replaces it with a copy of the flight plan being activated. Inverting a stored flight plan reverses the waypoint order, erases the active flight plan, and replaces it with the flight plan being activated (the stored flight plan is not changed).

**Activating a stored flight plan:**

- 1) From the **Main Menu**, touch **Flight Plan List**.
- 2) Touch the desired saved flight plan. An option menu is displayed.
- 3) Touch **Activate**. A confirmation window appears.
- 4) Touch **Yes**.

**Activating a Flight Plan Leg:**

- 1) From the **Main Menu**, touch **Active Flight Plan**.
- 2) While navigating an active flight plan, touch the desired leg to be activated. An option menu automatically appears.
- 3) Touch **Activate Leg**.
- 4) Touch **Yes**.

**EDITING SPEED AND FUEL FLOW**

**Adjusting the Flight Plan cruise speed and fuel flow:**

- 1) From the **Main Menu**, touch **Tools > Profile**.
- 2) If necessary, touch the desired Aircraft Identifier.
- 3) Touch **Flight planning cruise speed** and/or **Flight planning fuel flow** Fields to enter the desired value using the keypad and touch **Enter**.



**Flight Plan Speed and Fuel Flow**

## COPYING FLIGHT PLANS

The aera allows copying a flight plan into a new flight plan memory slot, allowing editing, etc., without affecting the original flight plan. This can be used to duplicate an existing stored flight plan for use in creating a modified version of the original stored flight plan.

### Copying a stored flight plan:

- 1) From the **Main Menu**, touch **Flight Plan List** and touch the desired Flight Plan.
- 2) Touch **Copy** > **Yes**.

## DELETING FLIGHT PLANS

Individual or all stored flight plans can be deleted from the aera memory.

### Deleting a stored flight plan:

- 1) From the **Main Menu**, touch **Flight Plan List** and touch the desired Flight Plan.
- 2) Touch **Delete** > **Yes**.

### Deleting all stored flight plans:

From the **Main Menu**, touch **Flight Plan List** > **Menu** > **Delete All** > **Yes**.



**NOTE:** The changes made to the active flight plan affect navigation as soon as they are entered. Editing the active flight plan does not affect any saved flight plans. Waypoints in the final approach segment (such as the FAF or MAP) can not be deleted individually.

### Deleting the Active Flight Plan:

From the **Main Menu**, touch **Active Flight Plan** > **Menu** > **Stop Navigation**.

### Deleting an individual waypoint from the active flight plan:

- 1) From the **Main Menu**, touch **Active Flight Plan**.
- 2) While navigating an active flight plan, touch the waypoint to be deleted. An option menu appears.
- 3) Touch **Remove** > **Yes**.

### Deleting an individual waypoint from a saved flight plan:

- 1) From the **Main Menu**, touch **Flight Plan List**.
- 2) Touch the desired saved flight plan. An option menu is displayed.
- 3) Touch **Edit**.
- 4) Touch the desired waypoint to be deleted. An option menu appears.
- 5) Touch **Remove > Yes**.

## INVERTING A FLIGHT PLAN

Any flight plan may be inverted (reversed) for navigation back to the original departure point.

### Inverting the active flight plan:

From the **Main Menu**, touch **Active Flight Plan > Menu > Invert > Yes**.

## 3.5 APPROACHES



**WARNING:** *The aera is not designed to be independently used for flight into instrument meteorological conditions (IMC) or other conditions in which aircraft control is based solely upon flight instruments. The approaches provided are for monitoring purposes only. Only the final course segment (final approach fix (FAF) to missed approach point (MAP)) of the published approach is available for monitoring.*

An approach can be loaded at any airport that has one available, and provides guidance for non-precision and precision approaches to airports with published instrument approach procedures. Only one approach can be loaded at a time in a flight plan. If an approach is loaded when another approach is already in the active flight plan, the new approach replaces the previous approach. Only the final course segment (Final Approach Fix (FAF) to Missed Approach Point (MAP)) of the published approach is available for monitoring.

Whenever an approach is selected the aera automatically activates the approach. The procedure is added to the end of the flight plan and immediately begins to provide guidance to the first waypoint in the approach.



Select Approach

## SELECTING AN APPROACH

When selecting an approach, it replaces the destination airport with the sequence of waypoints for the selected approach. Keep in mind that the airport must have a published approach (GPS, RNAV, VOR, NDB, localizer, or ILS) and only the final course segment (final approach fix to missed approach point) of the published approach is available in the aera. If the airport does not have a published approach, the 'Select Approach' menu option is not available.

An approach can be selected using the Direct-to, Active Flight Plan, and the Saved Flight Plan functions.

### Selecting an approach from the active or saved flight plan:

- 1) From the **Main Menu**, touch **Active Flight Plan**.
  - Or:**
  - a) From the **Main Menu**, touch **Flight Plan List**.
  - b) Touch the desired Flight Plan from the list. An option menu appears.
  - c) Touch **Edit**.
- 2) With the flight plan displayed, touch **Menu**.
- 3) Touch **Select Approach** (only available if the destination airport has a published approach).
- 4) Touch  to display a list of approaches.
- 5) Touch the desired approach.
- 6) Touch **Load Approach**, **Activate Approach**, or **Activate Vectors-to-Final**. The designated transition waypoints are added to the flight plan.

## Selecting an approach using the Direct To function:

- 1) Touch the **Direct To** Icon.
- 2) Touch the **Menu** Icon.
- 3) Touch **Select Approach** (only available when navigating a flight plan).
- 4) Touch  to display a list of approaches.
- 5) Touch the desired approach.
- 6) Touch **Load Approach**, **Activate Approach**, or **Activate Vectors-to-Final**. The designated transition waypoints are added to the flight plan.

## Resuming the Flight Plan after activating an approach:

Whenever an approach is selected and activated the procedure is added to the end of the flight plan and the aera immediately begins to provide guidance to the first waypoint in the approach. Follow the steps below to resume the flight plan after activating the approach.

- 1) From the **Main Menu**, touch **Active Flight Plan**.  
**Or:**  
Touch the **Direct To** Icon.
- 2) With a flight plan and an approach activated, touch the **Menu** Icon.
- 3) Touch **Resume Flight Plan**.

## Removing an approach:

- 1) From the **Main Menu**, touch **Active Flight Plan**.  
**Or:**
  - a) From the **Main Menu**, touch **Flight Plan List**.
  - b) Touch the desired Flight Plan from the list. An option menu appears.
  - c) Touch **Edit**.
- 2) With the flight plan displayed, touch **Menu**.
- 3) Touch **Remove** (only available if an approach is loaded).

## ACTIVATING VECTORS-TO-FINAL

After an approach has been activated, the 'Activate Vectors-to-Final' menu option is used when being vectored to the final approach course by Air Traffic Control (ATC).

When Vectors-to-Final are activated, the aera creates an extension of the final course, beyond the final approach waypoint in the database (final approach fix [FAF]). A Vector to Final symbol appears beside the first approach waypoint in the Active Flight Plan.

### Activating/Canceling Vectors-to-Final:

- 1) From the **Main Menu**, touch **Active Flight Plan**.
- 2) While navigating an Active Flight Plan (with an approach activated), touch the **Menu** icon.
- 3) Touch the active approach.
- 4) Touch **Activate Vectors-to-Final** or **Cancel Vectors-to-Final**.

Vectors-to-Final Symbol



Vectors-to-Final (Active Flight Plan)

Final Course Extension



Vectors-to-Final (Map)

The aera provides no guidance to the inbound course. The course deviation needle on the graphic HSI remains off-center until established on the final approach course. The map shows an extension of the final approach course using a bold magenta line.

If Vectors-to-Final are not activated, the aera creates a straight-line course directly to the first waypoint in the approach.

Loading the approach cancels the Direct-to and initiates a route to the FAF.



## SECTION 4 HAZARD AVOIDANCE

### 4.1 WEATHER

#### DATA LINK WEATHER (FIS-B)

FIS-B is a subscription-free weather service that is broadcast by Ground Based Transceivers (GBTs) over the 978 MHz UAT frequency band as part of the FAA's Next Generation Air Transportation System (NextGen). To receive FIS-B weather information, the weather/traffic device must be within range and line-of-sight of an operating GBT. Reception may be affected by altitude, terrain, and other factors. FIS-B weather products include METARs, TAFs, NEXRAD (Regional and CONUS (Combined)), AIRMETS, SIGMETs, PIREPs, and Winds and Temperatures Aloft. Other products include NOTAMs and TFRs.

##### Viewing FIS-B Weather product Status:

- 1) From the **Main Menu**, touch **Tools**.
- 2) Touch **Data Link**

##### Or:

- 1) From the **Main Menu**, touch **Weather**.
- 2) Touch **Menu > More Info**.

##### Viewing Ground Station Status:

- 1) From the **Main Menu**, touch **Tools**.
- 2) Touch **Data Link > Menu > Ground Stations**.

##### Or:

- 1) From the **Main Menu**, touch **Weather**.
- 2) Touch **Menu > More Info**.
- 3) Touch **Menu > Ground Stations**.

## FIS-B WEATHER PRODUCTS

FIS-B weather broadcasts are updated regularly and may take approximately ten minutes to transmit all available weather data. Therefore, weather data is not immediately available. No pilot action is required to receive FIS-B weather information. Weather product status can be viewed on the dedicated Weather Page, or the Data Link Page from the Tools menu.

When a FIS-B weather product is active on a map, the age of the data is displayed on the screen in the lower left corner. The age of the product is based on the time difference between when the data was assembled on the ground and the current GPS time. Weather products are broadcast at specific intervals (see broadcast interval in the table below).

If, for any reason, a weather product is not refreshed within the Expiration Time intervals (see table), the data is considered expired and is removed from the display. This ensures that only data that is consistent with FIS-B broadcast data is displayed. If more than half of the expiration time has elapsed, the color of the product age displayed changes to yellow. The system displays dashes instead of a product age when a product has expired.

The table below shows the FIS-B weather expiration time and the broadcast interval. The broadcast interval represents the interval at which FIS-B GBTs broadcast new signals that may or may not contain new weather data. It does not represent the rate at which weather data is updated or new content is received by weather/traffic devices.

FIS-B Products	Expiration Time	Update Interval (Minutes)	Broadcast Interval (Minutes)
NEXRAD Composite Reflectivity (CONUS)	60 minutes	~5 minutes precipitation mode 10 minutes for clear air	15
NEXRAD Composite Reflectivity (Regional)	60 minutes	As Available	2.5

FIS-B Products	Expiration Time	Update Interval (Minutes)	Broadcast Interval (Minutes)
METAR	8 hours	1 minute (where available), As Available otherwise	5
TAF	12 hours	8 hours	10
AIRMET	12 hours	As Available	5
SIGMET	12 hours	As Available, then at 15 minute intervals for 1 hour	5
PIREP	8 hours	As Available	10
Winds and Temperatures Aloft	12 hours	12 hours	10
NOTAM (D)/FDC (Including TFRs)	12 hours	As Available	10

### Weather Product Timing

## NEXRAD

NEXRAD (NEXt-generation RADar), is a network of multiple high-resolution Doppler radar sites that are operated by the National Weather Service (NWS). NEXRAD data provides centralized meteorological information for the continental United States and selected overseas locations. The maximum range of a single NEXRAD radar site is 250 nm. In addition to a wide array of services, the NEXRAD network provides important information about severe weather and air traffic safety.

NEXRAD data is not real-time. The lapsed time between collection, processing, and dissemination of NEXRAD images can be significant and may not reflect the current radar synopsis. Due to the inherent delays and the relative age of the data, it should be used for long-range planning purposes only. Never use NEXRAD data or any radar data to maneuver in or near areas of hazardous weather.

Composite data from all the NEXRAD radar sites in the United States is shown. This data is composed of the maximum reflectivity from the individual radar sweeps. The display of the information is color-coded to indicate the weather severity level.

The display of radar coverage is always active when NEXRAD is selected. Areas where NEXRAD radar coverage is not currently available or is not being collected are indicated in grayish-purple on the NEXRAD weather page. Radar capability exists in these areas, but it is not active or is off-line.

### NEXRAD Abnormalities

There are possible abnormalities regarding displayed NEXRAD images. Some, but not all, of those include:

- Ground clutter
- Strokes and spurious radar data
- Sun strobes, when the radar antenna points directly at the sun
- Military aircraft deploy metallic dust (chaff) which can cause alterations in radar scans
- Interference from buildings or mountains, which may cause shadows
- Poor reception from Ground Based Transceivers (GBTs) can cause portions of the received radar imagery to not be displayed

### NEXRAD Limitations

Certain limitations exist regarding the NEXRAD radar displays. Some, but not all, are listed for the user's awareness:

- NEXRAD base reflectivity does not provide sufficient information to determine cloud layers or precipitation characteristics (hail vs. rain). For example, it is not possible to distinguish between wet snow, wet hail, and rain.
- NEXRAD base reflectivity is sampled at the minimum antenna elevation angle. An individual NEXRAD site cannot depict high altitude storms at close ranges, and has no information about storms directly over the site.

### NEXRAD INTENSITY

Colors are used to identify the different NEXRAD echo intensities (reflectivity) measured in dBZ (decibels of Z). "Reflectivity" (designated by the letter Z) is the amount of transmitted power returned to the radar receiver. The dBZ values increase as returned signal strength increases. Precipitation intensity is displayed using colors corresponding to the dBZ values.

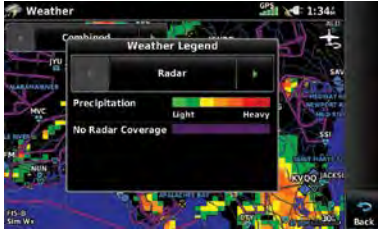

**RADAR Legend**

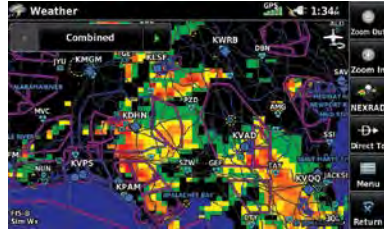

**NEXRAD Data**

### FIS-B RADAR PRODUCTS

FIS-B weather provides two different Radar products, CONUS and Regional. The system can display each individually or a composite (COMBINED). When Regional Radar is displayed, only precipitation for the current region is displayed. The subdued (grayish-purple colored) area represents the area not covered by the regional radar product. When Combined radar data is viewed, Regional Radar data is displayed on top of CONUS data and the time shown in the lower left corner is associated with Regional Radar data only.

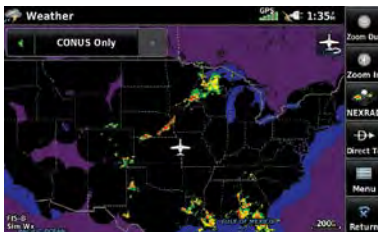

**FIS-B Radar CONUS**

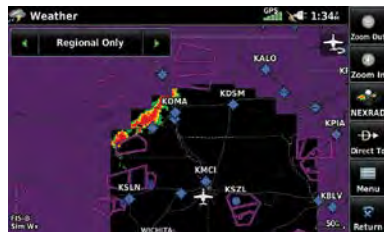

**FIS-B Radar Regional**

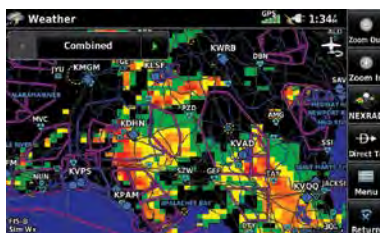

FIS-B Radar Combined

## WINDS ALOFT

Winds Aloft data shows the forecasted wind speed and direction in 3,000-foot increments up to 39,000 feet MSL.

Winds Aloft are displayed using wind barbs. The wind barbs indicate wind speed and direction.

The wind barbs always point in the direction that the wind is coming from. The wind speed is depicted using flags at the end of the wind barb. A short wind flag is 5 knots, a long wind flag is 10 knots, and a triangle flag is 50 knots.

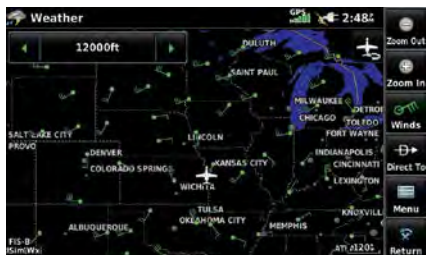

Winds Aloft Data

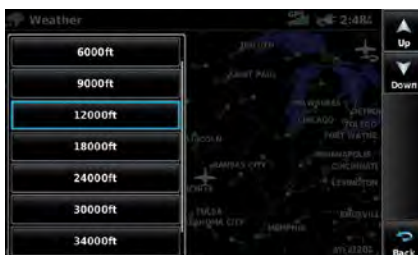

Winds Aloft Altitudes

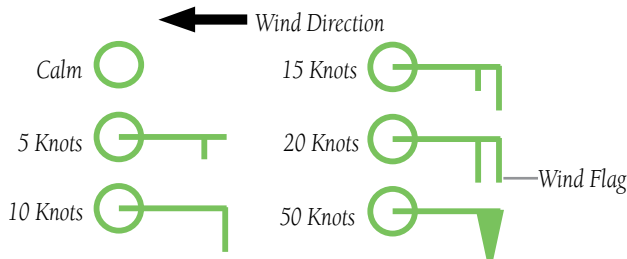

Winds Barbs

## TEMPERATURES ALOFT

Temperature Aloft data shows the forecasted temperatures aloft in 3,000-foot increments up to 39,000 feet MSL. For altitudes 18,000 feet and above the relative ISA temperature is shown. Temperatures are color coded with temperatures near and below freezing are shown as shades of blue, green for temperatures just above freezing and shades of orange are used for warmer temperatures.



Temperatures Aloft Data



Temperatures Aloft Altitudes

## METARS AND TAFS



**NOTE:** METAR information is only displayed within the installed aviation database service area.

METAR (METeological Aerodrome Report) is an international code used for reporting weather observations. METARs are updated hourly or as needed. METARs typically contain information about the temperature, dewpoint, wind, precipitation, cloud cover, cloud heights, visibility, and barometric pressure. They can also contain information on precipitation amounts, lightning, and other critical data. If METAR data is available for an airport, a color-coded flag is shown next to the airport.

TAF (Terminal Area Forecast) is the standard format for 24-hour weather forecasts. TAFs may contain some of the same code as METAR data. It typically forecasts significant weather changes, temporary changes, probable changes, and expected changes in weather conditions.

An abbreviated version can be viewed by selecting the METAR flag with the map pointer. Touching the Map Feature Button will display additional information. METAR and TAF data can be displayed as raw or decoded text.







Map Feature Button

**METAR Data (Map)**



**Additional METAR Data**

The METAR flag color is determined by the information in the METAR text.

-  VFR (ceiling greater than 3000 feet AGL and visibility greater than 5 miles)
-  Marginal VFR (ceiling 1000-3000 feet AGL and/or visibility 3-5 miles)
-  IFR (ceiling 500 to below 1000 feet AGL and/or visibility 1 mile to less than 3 miles)
-  Low IFR (ceiling below 500 feet AGL or visibility less than 1 mile)
-  METAR text does not contain adequate information to determine flight conditions

## AIRMETS

An AIRMET (AIRmen's METeoroological Information) can be especially helpful for pilots of light aircraft that have limited flight capability or instrumentation. An AIRMET must affect or be forecast to affect an area of at least 3,000 square miles at any one time. AIRMETS are routinely issued for six-hour periods and are amended as necessary due to changing weather conditions. AIRMETS are displayed as colored, dashed lines.



## SIGMETS

A SIGMET (SIGNificant METeorological Information) advises of weather that is potentially hazardous to all aircraft. In the contiguous United States, the following items are covered: severe icing, severe or extreme turbulence, volcanic ash, dust storms, and sandstorms that lower visibility to less than three statute miles.

A Convective SIGMET is issued for the following conditions: thunderstorms, isolated severe thunderstorms, embedded thunderstorms, hail at the surface, and tornadoes.

A SIGMET is widespread and must affect or be forecast to affect an area of at least 3,000 square miles. SIGMETs are displayed as a yellow-dashed line.



**AIRMET Selected**

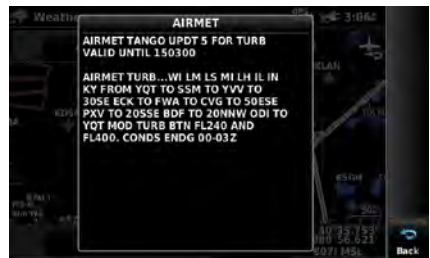

**Additional AIRMET Data**

## TEMPORARY FLIGHT RESTRICTIONS (TFR)



**NOTE:** Do not rely solely upon data link services to provide Temporary Flight Restriction TFR information. Always confirm TFR information through official sources such as Flight Service Stations of Air Traffic Control.

Temporary Flight Restrictions, or TFRs, temporarily restrict all aircraft from entering the selected airspace unless a waiver has been issued. TFRs are routinely issued for activities such as sporting events, dignitary visits, military depots, and forest fires. TFRs are represented as an area highlighted by red (active) or yellow (not yet active).



Map Feature Button

TFR Data Selected



Additional TRF Information

## PIREPS

Pilot Weather Reports (PIREPs) provide timely weather information for a particular route of flight. When significant weather conditions are reported or forecast, Air Traffic Control (ATC) facilities are required to solicit PIREPs. A PIREP may contain unforecast adverse weather conditions, such as low in-flight visibility, icing conditions, wind shear, and turbulence. PIREPs are issued as either Routine (UA) (blue) or Urgent (UUA) (yellow).

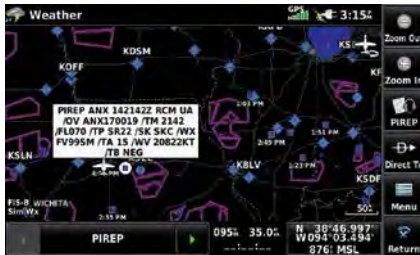

Map Feature Button

PIREP Selected

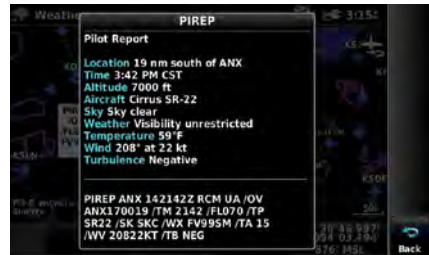

Additional PIREP Data

## USING FIS-B WEATHER PRODUCTS



**WARNING:** Do not use data link weather information for maneuvering in, near, or around areas of hazardous weather. Information contained within data link weather products may not accurately depict current weather conditions.



**WARNING:** Do not use the indicated data link weather product age to determine the age of the weather information shown by the datalink weather product. Due to time delays inherent in gathering and processing weather data for data link transmission, the weather information shown by the data link weather product may be significantly older than the indicated weather product age.

FIS-B Weather Products can be displayed on the Map Page and individually on the Weather (WX) Page.

The setup menu for the Map Page controls the map range settings above which weather products are decluttered from the display. If a map range larger than the weather product map range setting is selected, the weather product data is removed from the map. The menu also provides a means for enabling/disabling display of 'Airmets', 'Sigmet's', 'Weather Data', and/or 'NEXRAD' on the Map Page.

Additional information about the following can be displayed by panning over the display on the Weather Page or the Map Page:

- SIGMETs
- METARs
- AIRMETs
- TFRs

Additional information is also available for PIREPs on the Weather Page (not displayed on the Map Page):

### Viewing FIS-B Weather products on the Navigation Map:

- 1) From the **Main Menu**, touch **Map**.
- 2) Touch **Menu**.
- 3) Touch **Weather**.

### Viewing FIS-B Weather products on the Weather Map:

- 1) From the **Main Menu**, touch **Weather**.
- 2) Touch the Dedicated Page Icon and touch the desired weather data (**NEXRAD**, **Winds**, **Temps**, **METAR**, **AIRMET**, **SIGMET**, **TFR**, or **PIREP**).
- 3) If necessary, touch the  buttons to change the altitudes, AIRMET types, or NEXRAD regions displayed.
- 4) Touch the desired weather product to get abbreviated information about the selected weather product (if available).
- 5) With the desired weather product highlighted, touch the Map Feature Button to get detailed information (if available).

### Setting up and customizing weather data for the Navigation Map:

- 1) From the **Main Menu**, touch **Map** > **Menu** > **Set Up Map**.
- 2) Touch the Dedicated Page Icon and touch **Weather**.
- 3) Touch **On/Off** to display (**FIS-B Weather Data**, **NEXRAD**, **Radar Coverage**, **AIRMETS**, or **SIGMETS**).
- 4) Touch the METAR  button and touch **Auto**, or touch a desired map range from the list.

### Restoring default weather data for the Navigation Map:

- 1) From the **Main Menu**, touch **Map** > **Menu** > **Set Up Map**.
- 2) Touch the Dedicated Page Icon and touch **Weather**.
- 3) Touch **Menu**.
- 4) Touch **Restore Category Defaults**.

### Viewing legends for displayed weather products:

- 1) From the **Main Menu**, touch **Map**.  
**Or:**
  - a) From the **Main Menu**, touch **Weather**.
  - b) Touch the Dedicated Page Icon and touch the desired weather data (**NEXRAD**, **Winds**, **Temps**, **METAR**, **AIRMET**, **SIGMET**, **TFR**, or **PIREP**).
- 2) Touch **Menu**.
- 3) Touch **Weather Legend**.
- 4) If desired, touch the  buttons until the desired legend is displayed.

### Animating FIS-B weather:

- 1) From the **Main Menu**, touch **Map** (weather must be enabled).  
**Or:**
  - a) From the **Main Menu**, touch **Weather**.
  - b) Touch the Dedicated Page Icon and touch **NEXRAD**.
- 2) Touch **Menu**.
- 3) Touch **Animate Weather**.

## 4.2 TERRAIN



**WARNING:** Do not use Terrain information for primary terrain avoidance. Terrain information is intended only to enhance situational awareness.



**NOTE:** Terrain depicted in the Profile View is always “ahead” of the aircraft, and will change as ground track changes.

The Terrain function displays altitudes of terrain and obstructions relative to the aircraft position and altitude with reference to a database that may contain inaccuracies. Terrain and obstructions are shown only if they are in the database. Terrain and obstacle information should be used as an aid to situational awareness. They should never be used to navigate or maneuver around terrain.

Note that all obstructions may not be available in the terrain and obstacle database. No terrain and obstacle information is shown without a valid 3-D GPS position.

The aera GPS receiver provides the horizontal position and altitude of the aircraft. Aircraft GPS altitude is derived from satellite position. GPS altitude is then converted to a mean sea level (MSL)-based altitude (GPS-MSL altitude) and is used to determine terrain and obstacle proximity. GPS-MSL altitude accuracy is affected by satellite geometry, but is not subject to variations in pressure and temperature that normally affect pressure altitude sensors. GPS-MSL altitude does not require local altimeter settings to determine MSL altitude. It is a widely-used MSL altitude source.

Terrain and obstacle databases are referenced to MSL. Using the GPS position and altitude, the Terrain feature portrays a 2-D picture of the surrounding terrain and obstacles relative to the position and altitude of the aircraft. GPS position and GPS-MSL altitude are used to calculate and predict the aircraft's flight path in relation to the surrounding terrain and obstacles. In this way, the pilot can view predicted dangerous terrain and obstacle conditions.

Alert windows appear to inform the pilot of proximity to the terrain and obstacles, as well as an unsafe descent rate. These alerts depend on user-defined parameters in the Terrain Setup.

## TERRAIN INFORMATION

---

Two views are displayed by the Terrain function: the Map View, and the Profile View. The areas of the terrain shaded red are predicted to be within 100 feet below or above the aircraft. The yellow terrain areas are between the user-defined Caution Elevation and 100 feet below the aircraft. By default, the Caution Elevation is 1,000 feet; therefore, the areas in yellow are between 1,000 feet and 100 feet below the aircraft. The black areas are further than the Caution Elevation. A projected point of impact is marked with an "X" symbol.

## OBSTACLE INFORMATION

---

Obstacles are shown on the Terrain Map View, at or below the map range of 12 nm. Obstacles are also shown on the Navigation Map when the map range is set to 5 nm or below.

Standard aeronautical chart symbols are used for lighted or unlighted obstacles taller than 200 feet Above Ground Level (AGL). Refer to the Obstacle Icons legend below.

When selecting an obstacle with the Map Pointer, each obstacle displays the altitude at the top of the obstacle, or Mean Sea Level (MSL). Each obstacle also lists the actual height of the obstacle, or Above Ground Level (AGL).

Unlighted Obstacle		Lighted Obstacle		Power Lines	Potential Impact Points	Obstacle Location
< 1000' AGL	> 1000' AGL	< 1000' AGL	> 1000' AGL			
						WARNING: Red obstacle is above or within 100' below current aircraft altitude
						CAUTION: Yellow obstacle is between 100' and 1000' below current aircraft altitude

Terrain Obstacle Colors and Symbology

## TERRAIN AND OBSTACLE COLOR CODE

Red—terrain or obstacle is above or within 100 feet below the aircraft.

Yellow—terrain or obstacle is between the user-defined Caution Elevation and 100 feet below the aircraft.

### Enabling/Disabling Terrain Shading on the Navigation Map:

- 1) From the **Main Menu**, touch **Map**.
- 2) Touch **Menu**.
- 3) Touch **Terrain**.

## TERRAIN VIEWS

### Enabling/disabling profile view:

- 1) From the **Main Menu**, touch **Terrain**.
- 2) Touch **Menu**.
- 3) Touch **Profile View**.

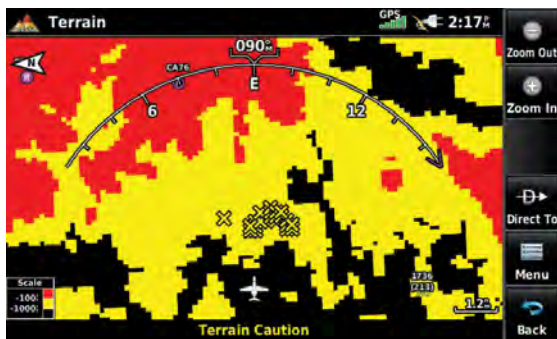
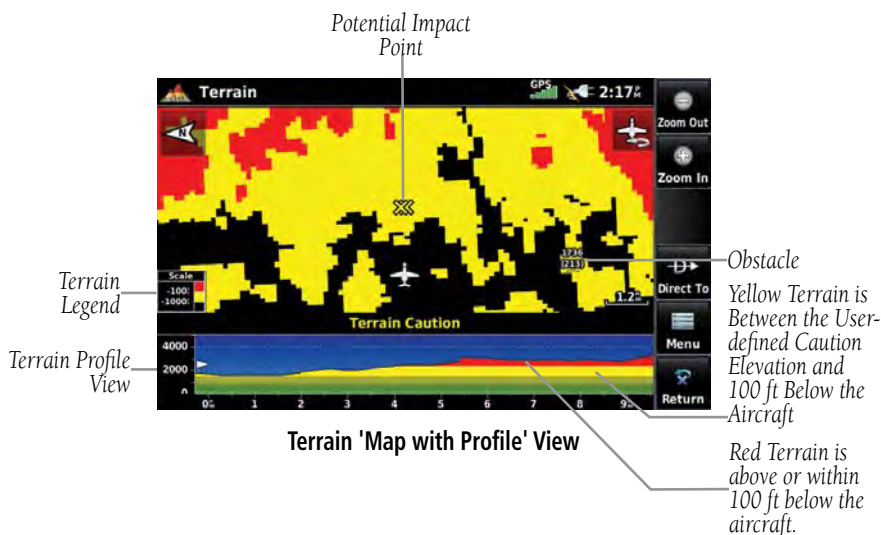

Terrain 'Map Only' View

## TERRAIN ALERTS & SETUP

### Enabling/Disabling terrain alerts:

- 1) From the **Main Menu**, touch **Terrain**.
- 2) Touch **Menu**.
- 3) Touch **Alerts** to toggle between **Enabled** and **Inhibited**.

Use the Terrain Setup Menu to set levels for terrain alerts as well as obstacles in or near the flight path.



- **Caution Elevation**—The aera will provide an alert if the terrain or obstacle is within the default Caution Elevation or user-defined Caution Elevation
- **Look Ahead Time**—Determines the maximum time when an alert annunciation occurs. For example, if 120 seconds is selected, the aera provides an alert up to 120 seconds before reaching the terrain or obstacle
- **Alert Sensitivity**—The three Alert Sensitivity settings (Terrain, Obstacle, and Descent Rate) determine what level of alerts are annunciated. The aera defaults to 'High' sensitivity, which annunciates all red and yellow alerts at the time set in Look Ahead Time. 'Medium' sensitivity annunciates all of the red and the highest priority of yellow alerts. 'Low' only annunciates red alerts. 'Off' disables the alert.

### Accessing terrain/obstacle settings:

- 1) From the **Main Menu**, touch **Terrain**.
- 2) Touch **Menu**.
- 3) Touch **Caution Elevation**, and touch **500ft Below**, **750ft Below**, or **1000ft Below**.
- 4) Touch **Look Ahead Time**, and touch **60 Seconds**, **90 Seconds**, or **120 Seconds**.
- 5) Touch **Terrain** 'Alert Sensitivity', and touch **Off**, **Low**, **Medium**, or **High**.
- 6) Touch **Obstacles** 'Alert Sensitivity', and touch **Off**, **Low**, **Medium**, or **High**.
- 7) Touch **Descent Rate** 'Alert Sensitivity', and touch **Off**, **Low**, or **High**.

Terrain, Obstacle, and Descent Rate Alerts are issued when flight conditions meet parameters that are set within the software algorithms. Terrain alerts typically employ a CAUTION or a WARNING alert severity level, or both. When an alert is issued, visual annunciations are displayed and aural alerts are simultaneously issued. When the aircraft descends through 500 feet above the destination airport an audible "Five Hundred" altitude reminder occurs.

The Terrain Alert Annunciation is shown to the lower left corner of the screen. If the Terrain Map is not displayed, a pop-up alert appears. The Range Rings on the pop-up alert are spaced every whole mile/kilometer/nautical mile. Touch the Terrain Alert Annunciation to acknowledge the pop-up and/or aural alert.

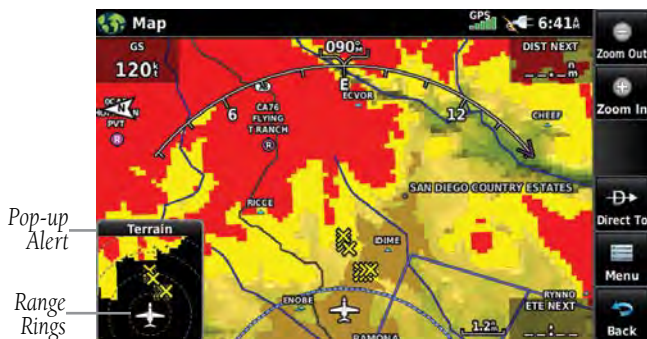

Pop-up Alert (Navigation Map With Terrain Shading)

## AURAL ALERTS

- “Five Hundred”—when the aircraft descends through 500 feet above the destination airport.

The following aural terrain alerts are issued when flight conditions meet parameters that are set within the software algorithms, and are dependant on the sensitivity level set in the Terrain Setup Menu.

Alert Severity	Terrain	Obstacle	Descent Rate
<b>Caution</b>	“caution, terrain” “caution, terrain ahead”	“caution, obstacle” “caution, obstacle ahead”	“caution, sink rate”
<b>Warning</b>	“terrain ahead! pull up!” “terrain! terrain! pull up! pull up!”	“obstacle ahead! pull up!” “obstacle! obstacle! pull up! pull up!”	“sink rate, pull up!” “pull up!”

### Aural Alerts Summary

#### Adjusting terrain alert audio:

- 1) From the **Main Menu**, touch **Tools > Setup > Sound**.
- 2) Touch the '**Terrain Audio**' **Enable** Button to toggle the terrain audio on/off:

## 4.3 TRAFFIC

### TRAFFIC INFORMATION SERVICE (TIS-A)





**NOTE:** Refer to Appendix F for general information regarding TIS-A. Refer to Appendix D for configuration information.

The aera supports TIS-A input from a Garmin Mode S transponder, such as the GTX 330.

#### TIS-A SYMBOLOGY

TIS-A traffic is shown according to TCAS symbology, graphically shown on the Navigation Map, and in the Traffic Warning Window. A Traffic Advisory (TA) symbol appears as a solid yellow circle. All other traffic is shown as a hollow white diamond. Altitude deviation from own aircraft altitude is shown above the target symbol if traffic is above own aircraft altitude, and below the symbol if they are below own aircraft altitude. Altitude trend is shown as an up arrow (>+500 ft/min), down arrow (<-500 ft/min), or no symbol if less than 500 ft/min rate in either direction.

TIS-A Symbol	Description
	Traffic Advisory (TA)
	Other Traffic

TIS-A Traffic Symbols

#### TIS-A ALERTS

A TIS-A audio alert is generated whenever the number of Traffic Advisories on the aera screen increases from one scan to the next. Limiting Traffic Advisories only reduces the “nuisance” alerting due to proximate aircraft. For example, when the first Traffic Advisories appear on the TIS-A display, the user is alerted audibly. So long as a single aircraft remains on the TIS-A display, no further audio alert is generated. If a second (or more) aircraft appears on the screen, a new audio alert is sounded.

If the number of Traffic Advisories on the TIS-A display decreases and then increases, a new audio alert is sounded. The TIS-A audio alert is also generated whenever TIS-A service becomes available. The following TIS-A audio alerts are available:

- "Traffic"—TIS-A traffic alert received.
- "Traffic Not Available"—TIS-A service is not available or out of range.

### Adjusting TIS-A audio:

- 1) From the **Main Menu**, touch **Tools** > **Setup** > **Sound**.
- 2) Touch the '**TIS Audio**' **Enable** Button to toggle the TIS Audio on/off.

## TRAFFIC WARNING WINDOW

When a traffic threat is imminent, the Traffic Warning Window is shown. The Traffic Warning Window shows a small pop-up map in the lower left corner. The Range Rings on the pop-up alert are spaced every whole mile/kilometer/nautical mile. Touch the Traffic Warning Window to acknowledge and remove it.



**NOTE:** The Traffic Warning Window is disabled when the aircraft ground speed is less than 30 knots or when on the approach leg of a route.

## TRAFFIC GROUND TRACK

Traffic ground track is indicated on the aera screen by a "target track vector," a short line shown in 45-degree increments, extending in the direction of target movement.

## DISPLAYING TRAFFIC DATA

TIS-A traffic can be displayed on the Navigation Map.

### Adjusting TIS-A settings on the navigation map:

- 1) From the **Main Menu**, touch **Map** > **Menu** > **Set Up Map**.
- 2) Touch the Dedicated Page Icon and touch the **Map** group.
- 3) Touch the **Traffic** button and touch the desired setting (**Off**, **Auto**, or range settings).

**Displaying TIS-A information using the map pointer:**

With traffic displayed on the Navigation Map, touch the desired TIS-A symbol on the map. The traffic range and altitude separation are displayed.

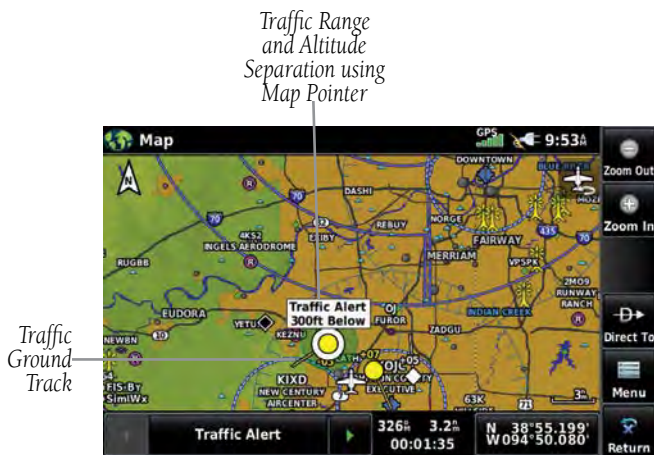

TIS-A (Navigation Map)

**DATA LINK TRAFFIC**

ADS-B (Automatic Dependent Surveillance-Broadcast) is a surveillance technology deployed across the United States as the cornerstone of the FAA’s Next Generation Air Transportation System (NextGen). ADS-B enables improved surveillance services, both air-to-air and air-to-ground, especially in areas where radar is ineffective due to terrain or where it is impractical or cost prohibitive. Initial applications of air-to-air ADS-B are for “advisory” use only, enhancing a pilot’s visual acquisition of other nearby ADS-B equipped aircraft either when airborne or on the airport surface.

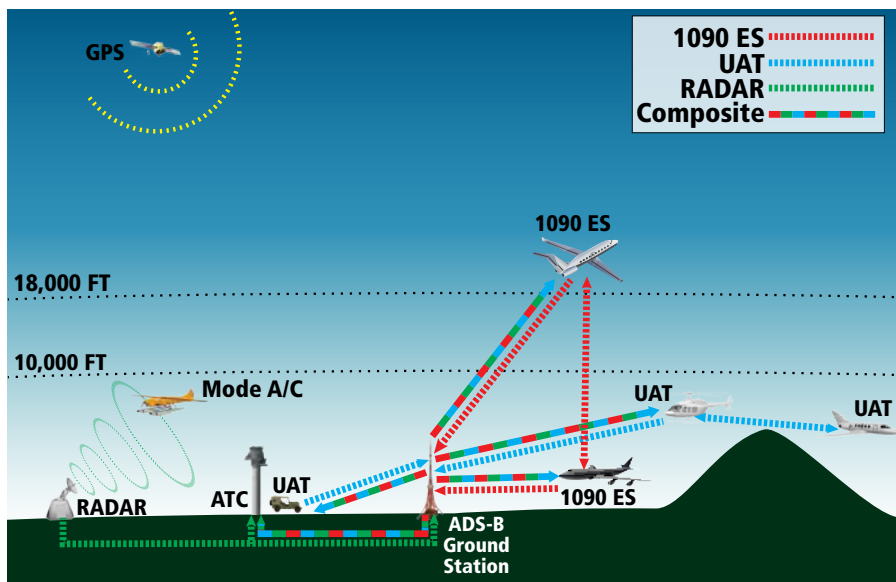

ADS-B System

For the purpose of distinguishing between levels of ADS-B service, there are three classifications of aircraft or system capability; ADS-B In, ADS-B Out, and ADS-B participating. ADS-B In refers to the capability to receive ADS-B information. ADS-B Out refers to the capability to transmit ADS-B information. ADS-B participating refers to the capability to both send and receive ADS-B information. Aircraft lacking either ADS-In, ADS-B Out, or both ADS-B capabilities may also be referred to as ADS-B non-participating aircraft.

Currently, rule-compliant ADS-B Out capability in the United States requires a TSO'ed SBAS-enabled GPS, such as a Garmin GPS 400W or similar, and one of two possible data links: 1090 ES transponder or a 978 MHz UAT. Either data link system is capable of transmitting the aircraft's position, velocity, identification, and other information every second to compatible aircraft and ground stations called Ground Based Transceivers (GBTs).

Because 1090 ES transponders and UATs operate on different frequencies, aircraft not similarly equipped cannot transmit/receive data link information directly to/from each other. Instead, operation within range of a GBT is required to receive data link information on both frequencies.

Thus, the weather/traffic device receives traffic information directly from any ADS-B Out aircraft within range as well as the rebroadcast of ADS-B information from any nearby GBT. This rebroadcast is called Automatic Dependent Surveillance-Rebroadcast (ADS-R) and is automatically triggered by the detection of an ADS-B participating aircraft within the service volume of the GBT. The weather/traffic can receive both the Traffic Information Service-Broadcast (TIS-B) and Flight Information Service-Broadcast (FIS-B) provided in conjunction with ADS-R services when in range of a GBT.

FIS-B service is provided continuously, but ADS-R including TIS-B will only be broadcast by a GBT when an ADS-B participating aircraft is within the GBT's defined service volume. In this case, a GBT will only rebroadcast TIS-B information relative to the ADS-B participating aircraft. **Only traffic that is within 15 nm lateral and 3,500' vertical of the ADS-B participating aircraft is provided in the broadcast.** Non-participating traffic aircraft located farther than 15 nm laterally and 3,500' vertically from the participating aircraft is are excluded from the information transmitted by the GBT.

TIS-B traffic information includes non-participating aircraft detected by ATC surveillance radar. As TIS-B data is derived from ATC surveillance radar data, TIS-B traffic position updates typically occur every three to thirteen seconds. **Therefore, TIS-B traffic may be displayed with degraded positional accuracy. Aircraft without operating transponders are invisible to TIS-B. Aircraft operating outside of the ATC radar coverage area are also not displayed.**

Since weather/traffic devices are receive-only devices, even when used onboard an aircraft equipped with a qualifying GPS and 1090 ES transponder, a GBT may not identify it as an ADS-B participating aircraft. The squitter of some 1090 ES transponders, including the Garmin GTX 23ES, must be configured to communicate that the aircraft has 978 MHz receive capability in order to be identified as an ADS-B participating aircraft.



**WARNING:** Do not rely solely upon the display of traffic information for collision avoidance maneuvering. The traffic display does not provide collision avoidance resolution advisories and does not under any circumstances or conditions relieve the pilot's responsibility to see and avoid other aircraft.





**WARNING:** Do not rely solely upon the display of traffic information to accurately depict all of the traffic within range of the aircraft. Due to lack of equipment, poor signal reception, and/or inaccurate information from aircraft or ground stations, traffic may be present that is not represented on the display.

## Viewing the weather/traffic device status:

- 1) From the **Main Menu**, touch **Tools**.
- 2) Touch **Data Link**.

## SYSTEM STATUS

The traffic system status is annunciated in the upper right corner of the Map Page, as well as the bottom of the dedicated Traffic Page.

System Status	Traffic Icon
Full traffic services available for an ADS-B participating aircraft (ground linked TIS-B, FIS-B and ADS-R, and Air-to-Air ADS-B). If using a weather/traffic device on a non-participating aircraft, this traffic icon may still be visible when within the service area of any participating aircraft. As a non-participating aircraft the weather/traffic device is only receiving TIS-B traffic information for traffic within 15 nm and 3,500' of the participating aircraft.	
Limited traffic services available (may be limited to Air-to-Air ADS-B)	



System Status	Traffic Icon
No Traffic Data Available	

### Traffic Modes

Some weather/traffic devices also have a pressure altitude sensor to aid in displaying the relative altitude of received traffic information. If the weather/traffic device is used onboard a pressurized aircraft, the pressure altitude sensor should be turned off.

### Configuring a weather/traffic device for a pressurized or non-pressurized aircraft:

- 1) From the **Main Menu**, touch **Tools > Data Link**
- 2) Touch **Menu > Set Up Data Link**.
- 3) Touch the '**Aircraft Type**' **Pressurized** button to toggle pressurized aircraft on/off.

### TRAFFIC DESCRIPTION

ADS-B traffic operation is similar to TIS-A discussed previously, but ADS-B adds additional symbology and capabilities. The symbols used to display ADS-B traffic are shown in the table below. The traffic label and altitude are displayed below the traffic symbol. A small up or down arrow next to the traffic symbol indicates that the traffic is climbing or descending at a rate of at least 500 feet per minute. The vector line that extends from the traffic symbol is just further indication of the intruder aircraft track. For directional traffic symbols, the arrow head points in the direction of aircraft's ground track.

Symbol	Description
	Non-threat, non-directional airborne traffic
	Non-threat directional airborne Traffic with absolute vector. Points in the direction of the aircraft track.
	Non-directional airborne Proximity Advisory (PA). Proximity Advisories are issued for any traffic within 6 nautical miles and +/- 1,200'.
	Directional airborne Proximity Advisory (PA) with absolute vector. Points in the direction of the aircraft track. Proximity Advisories are issued for any traffic within 6 nautical miles and +/- 1,200'.
	Non-directional airborne Traffic Advisory (TA)
	Non-directional off-scale airborne Traffic Advisory (TA). Displayed at outer range ring at proper bearing.
	Directional airborne Traffic Advisory (TA) with absolute vector. Points in the direction of the aircraft track.
	Directional off-scale airborne Traffic Advisory (TA). Points in the direction of the aircraft track.
	*Ground traffic without directional information. Ground traffic is only displayed when own aircraft is below 1,500 feet AGL or on the ground.
	*Directional surface traffic. Ground traffic is only displayed when own aircraft is below 1,500 feet AGL or on the ground.
	*Non-directional non-aircraft ground traffic. Ground traffic is only displayed when own aircraft is below 1,500 feet AGL or on the ground.
	*Directional non-aircraft ground traffic. Ground traffic is only displayed when own aircraft is below 1,500 feet AGL or on the ground.
*Ground traffic is only displayed on the Map Page when the aircraft is on the ground or below 1,500 feet AGL. Ground traffic is always displayed on the dedicated traffic page.	

## ADS-B Traffic Symbology

## TRAFFIC ADVISORIES (TA)

TAs are issued for traffic when they are predicted to be within a specified volume of airspace around the aircraft in a specified amount of time. The protected volume and time interval varies based on the current geodetic altitude and groundspeed. Thus, the protected volume of airspace increases with altitude and ground speed. Refer to the following table for details.

Altitude (Geodetic)	Look Ahead Time (sec.)	Vertical Separation (ft.)	Horizontal Separation (nm.)
Below 5,000	30	+/-850	.35
5,000-10,000	40	+/-850	.55
10,000-20,000	45	+/-850	.80
20,000-42,000	48	+/-850	1.10
Above 42,000	48	+/-1,200	1.10

### Traffic Advisories

## TRAFFIC ALERTS (ADS-B TIS-B)

A traffic audio alert is generated whenever the number of Traffic Advisories on the aera display increases. Limiting Traffic Advisories only reduces the “nuisance” alerting due to proximate aircraft. For example, when the first Traffic Advisories appear on the display, the user is alerted audibly. So long as a single aircraft remains on the display, no further audio alert is generated. If a second (or more) aircraft appears on the screen, a new audio alert is sounded. Traffic Advisories can only be issued when the weather/traffic device knows its own altitude and the altitude of the intruder aircraft.

If the number of Traffic Advisories on the traffic display decreases and then increases, a new audio alert is sounded. The traffic audio alert is also generated whenever TIS-B service becomes available. The following traffic audio alerts are available:

- “Traffic”—TIS-B/ADS-B traffic alert received.
- “Traffic Not Available”—TIS-B/ADS-B service is not available or out of range.

## Disabling/Enabling the traffic alerts:



**NOTE:** Traffic alerts are reset to 'enabled' on the next power cycle.

- 1) From the **Main Menu**, touch **Traffic**.
- 2) Touch **Menu** > **Disable/Enable Alerts**.

## Adjusting alert volume:

- 1) From the **Main Menu**, touch **Tools** > **Setup** > **Sound**.
- 2) Touch the '**Traffic Audio**' **Enable** Button to toggle the Traffic audio on/off.

## TRAFFIC WARNING WINDOW

The Traffic Warning Window is shown when the weather/traffic device issues a traffic advisory (TA). The Traffic Warning Window shows a small pop-up map in the lower left corner. The Range Rings on the pop-up alert are spaced every whole mile/kilometer/nautical mile. Touch the Traffic Warning Window to acknowledge and remove it.

## DISPLAYING TRAFFIC DATA

Traffic is displayed by default on the Map Page and in the Traffic Warning Window. Traffic Symbol and Traffic Label (i.e., relative altitude, altitude trend and absolute motion vectors) settings selects the maximum range at which traffic labels or symbols are shown. Traffic Labels can also be turned off.

### Enabling/disabling traffic data on the Map Page:

- 1) From the **Main Menu**, touch **Map** > **Menu**.
- 2) Touch **Traffic** to enable/disable traffic data on the Map Page.

**Or:**

- 1) From the **Main Menu**, touch **Map** > **Menu** > **Set Up Map**.
- 2) Touch the Dedicated Page Icon and touch the **Traffic** group.
- 3) Touch the '**Traffic Data**' **On** or **Off** button.

### Customizing the traffic data on the Map Page:

- 1) From the **Main Menu**, touch **Map** > **Menu** > **Set Up Map**.
- 2) Touch the Dedicated Page Icon and touch the **Traffic** group.
- 3) Touch '**Traffic Symbol**' or '**Traffic Label**' button and touch the desired settings ('**Off**', '**Auto**', or range settings).

**Displaying Traffic information using the map pointer:**

With traffic displayed on the Navigation Map, touch the desired Traffic symbol on the map to view identification, altitude and altitude trend information.



*Traffic Identification and Altitude*

Traffic Data (Navigation Map)

**DEDICATED TRAFFIC PAGE**

Altitude filter settings from the Traffic Page are carried to the Map Page.

**Viewing the Traffic Page:**

From the **Main Menu**, touch **Traffic**.

**Changing the Altitude Filter:**

- 1) From the **Main Menu**, touch **Traffic** > **Menu** > **Altitude Filter**.
- 2) Touch the desired setting:
  - **Unrestricted:** All traffic is displayed.
  - **Normal:** Displays non-threat and proximity traffic from 2,700 feet above the aircraft to 2,700 feet below the aircraft. Typically used during enroute phase of flight.
  - **Above:** Displays non-threat and proximity traffic from 9,000 feet above the aircraft to 2,700 feet below the aircraft. Typically used during climb phase of flight.
  - **Below:** Displays non-threat and proximity traffic from 2,700 feet above the aircraft to 9,000 feet below the aircraft. Typically used during descent phase of flight.

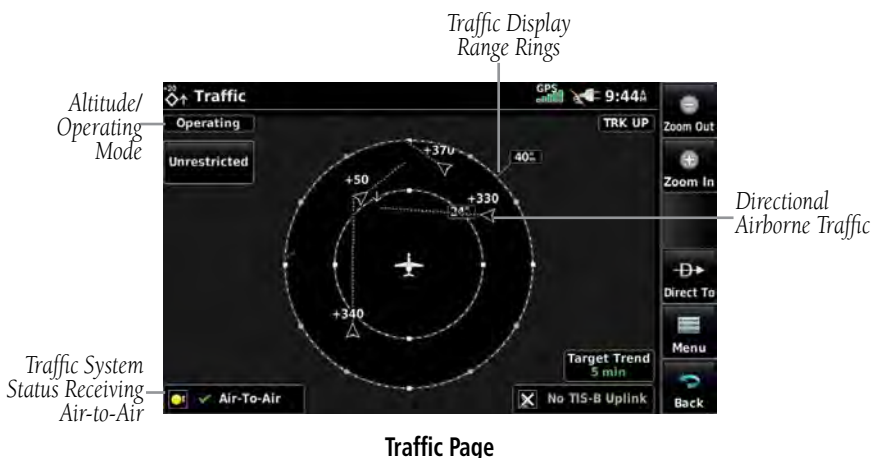

Traffic Page

## FLIGHT ID DISPLAY

The Flight IDs of other aircraft (when available) can be displayed on the Traffic Page. When a Flight ID or call sign is received, it will appear below the corresponding traffic symbol when enabled.



Example ADS-B Traffic Symbol

### Enabling/Disabling Flight ID Display:

From the **Main Menu**, touch **Traffic** > **Menu** > **Target Identifiers**.

## MOTION VECTORS

There are two pilot-selectable and mutually exclusive types of motion vectors, Absolute and TargetTrend, which are differentiated by color and function. Absolute vectors are white and indicate ground track as reported by the traffic. TargetTrend vectors are green and indicate the flight path and position, relative to the aircraft, at which the traffic will be after the passing of one of four predetermined time intervals. The end of the TargetTrend vector indicates the traffic's predicted location relative to the predicted location at the end of the look-ahead time. For example, if traffic is ahead of the aircraft and traveling along the same track but at a slower rate. The motion vector would point opposite of its indicated direction of flight showing that the aircraft is overtaking the traffic.



**TargetTrend**

The TargetTrend look-ahead time interval is automatically adjusted from 30 seconds to five minutes and corresponds to the traffic display range setting. The greater the range setting, the longer the time interval and vice versa. Refer to the table below for more details.

Traffic Page Range Ring Settings	TargetTrend Look-ahead
.5nm to 2nm	30 seconds
2nm to 6nm	60 seconds
6nm to 12nm	2 minutes
12nm to 40nm	5 minutes

**TargetTrend Look-ahead**

Motion vector selection is made from the Traffic Page Menu by enabling/disabling TargetTrend. Absolute vectors are selected by default and are replaced when TargetTrend is enabled.

### Enabling/Disabling TargetTrend:

From the **Main Menu**, touch **Traffic** > **Menu** > **Target Trend**.



# SECTION 5 ADDITIONAL FEATURES



**NOTE:** With the availability of SafeTaxi in electronic form, it is still advisable to carry another source of charts on board the aircraft.

## 5.1 SAFETAXI

SafeTaxi is an enhanced feature that gives greater map detail when viewing airports at close range. When viewing at ranges close enough to show the airport detail, the map reveals taxiways with identifying letters/numbers, runway incursion “Hot Spot”, and airport landmarks including ramps, buildings, control towers, and other prominent features. Resolution is greater at lower map ranges. The SafeTaxi feature can be seen on the Navigation Map or from the Waypoint Information Runway Tab.

Designated Hot Spots are recognized at airports with many intersecting taxiways and runways, and/or complex ramp areas. Airport Hot Spots are outlined to caution pilots of areas on an airport surface where positional awareness confusion or runway incursions happen most often. Hot Spots are defined by a red shaded area.

During ground operations the aircraft’s position is displayed in reference to taxiways, runways, and airport features. When panning over the airport, features such as runway holding lines and taxiways are shown at the cursor.

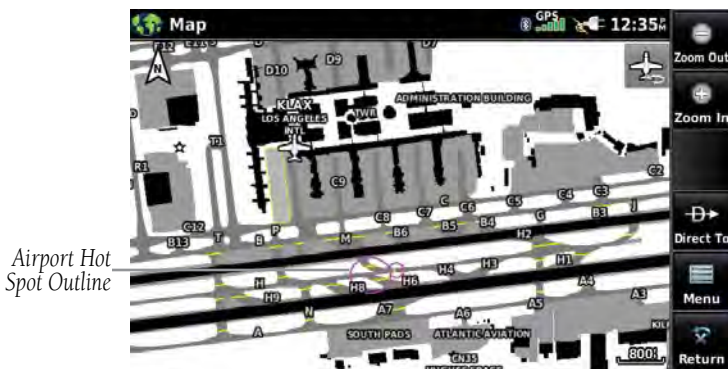

SafeTaxi Depiction

### Enabling/disabling SafeTaxi:

- 1) From the **Main Menu**, touch **Map > Menu > Set Up Map**.
- 2) Touch the Dedicated Page Icon and touch the **Airport** Group.
- 3) Touch the '**Safetaxi**' **On** or **Off** Button.

## SAFETAXI CYCLE NUMBER AND REVISION

SafeTaxi database is revised every 56 days. SafeTaxi is always available for use after the expiration date. When turning on the aera, the database initialization indicates whether the databases are current, out of date, or not available. The database initialization shows the SafeTaxi database is current when the SafeTaxi name and expiration date are shown in white. When the SafeTaxi cycle has expired, the SafeTaxi name and expiration date will appear in yellow.

The SafeTaxi Region, Cycle, Effective date and Expiration date of the database cycle can also be found from the **Main Menu**, by touching the **Tools > Database**.

The SafeTaxi database is provided by Garmin. Refer to Appendix C for instructions on updating the SafeTaxi database.

## 5.2 AIRPORT DIRECTORY DATA

The Airport Directory contains airport statistics such as pattern altitudes, noise abatement information, FBO phone numbers, hours of operation, local attractions, ground transportation, lodging, and services.

The AOPA Airport Directory provides data on airports and heliports throughout the U.S. and it is updated on a 56-day cycle. Detailed information for over 5,300 U.S. airports, along with the names and phone numbers of thousands of FBOs can be viewed. This service allows the pilot to plan an overnight, choose fuel stops, find ground transportation, etc.

Optional airport directory databases such as AC-U-KWIK are also supported. AC-U-KWIK provides complete listings of FBOs, charter companies, fuel suppliers, ground transportation, maintenance and catering services at public airports across the world.

If the AOPA database is in use, the **AOPA** Tab is displayed on the Waypoint Page. If another airport directory database is in use, such as AC-U-KWIK, the **DIRECTORY** Tab is displayed on the Waypoint Page.

## Viewing AOPA Airport Directory information:



- 1) From the **Main Menu**, touch **Waypoint** > **AOPA** Tab.
- 2) Touch the Waypoint Identifier Button.
- 3) Enter a waypoint identifier using the keypad and touch **Enter**.
  - Or:**
  - a) Touch **Find**.
  - b) Touch the **Recent, Nearest Airports, Flight Plan, or User** Tab.
  - c) Touch the desired waypoint.
  - Or:**
  - a) Touch **Find**.
  - b) Touch the **Search Name** Tab.
  - c) Touch **Search by Facility Name**.
  - d) Enter the desired Facility Name using the keypad.
  - e) Touch **Enter**.
  - Or:**
  - a) Touch **Find**.
  - b) Touch the **Search City** Tab.
  - c) Touch **Search by City**.
  - d) Enter the desired City using the keypad.
  - e) Touch **Enter**.
- 4) If duplicate entries exist for the entered facility name or location, duplicate waypoints are displayed. Touch the desired waypoint from the list.



Airport Directory Data

Or:

- 1) From any map highlight an airport using the Map Pointer.
- 2) Touch the Map Feature Button.
- 3) Touch the **AOPA** Tab (if necessary).

Icon	Description
	Restaurant on Field
	Self Serve Fuel
	Courtesy Car

Airport Directory Service Icons

## FUEL PRICES

Viewing fuel prices on the navigation map:

From the Main Menu, touch Map > Menu > Fuel Prices.



Navigation Map Menu

Fuel Prices



Fuel Prices (Navigation Map)

## SECTION 6 APPENDICES

## APPENDIX A: MESSAGES, ALERTS &amp; DATA FIELD OPTIONS

## MISCELLANEOUS MESSAGE ADVISORIES

Message	Comments
<b>Approaching Target Altitude</b>	Within 200 feet of final VNAV target altitude.
<b>Approaching VNAV Profile</b>	The aircraft is within one minute of reaching the initial VNAV decent point.
<b>Arriving at XXX</b>	The aircraft is nearing the destination.
<b>Battery Low</b>	The battery needs to be recharged.
<b>Can't Unlock Maps</b>	No applicable unlock code for one or more maps was found. All MapSource maps are not accessible.
<b>Database Error</b>	Internal problem with the system. Contact a Garmin dealer or Garmin Product Support to have the unit repaired.
<b>Fuel Tank</b>	A reminder for switching fuel tanks. The reminder message repeats at the specified interval after the beginning of each trip.
<b>Lost Satellite Reception</b>	The system is unable to receive satellite signals.
<b>Memory Full</b>	System memory is full, no further data can be saved.
<b>Near Proximity Point</b>	The aircraft has reached the distance set for a proximity waypoint.
<b>Next DTK XXX</b>	The aircraft is nearing a turn in a route.
<b>Proximity Memory Full</b>	No additional proximity waypoints can be saved.
<b>Proximity Radius Overlaps</b>	The radius of two proximity waypoints overlap.
<b>Route Already Exists</b>	A route name that already exists has been entered.

## MISCELLANEOUS MESSAGE ADVISORIES (CONT.)

Message	Comments
<b>Route Memory Full</b>	No additional routes can be saved.
<b>Route Truncated</b>	Uploaded route from another device has more than 300 waypoints.
<b>Route Waypoint Memory Full</b>	No additional route waypoints can be saved.
<b>Steep Turn Ahead</b>	Approaching a turn that requires a bank angle in excess of 25 degrees to stay on course.
<b>Track Already Exists</b>	A saved track with the same name already exists.
<b>Track Log Full</b>	The track log is full and track recording was turned off. To record more track points, clear the track log and turn track recording on.
<b>Track Memory Full</b>	No more track data can be stored. Delete the old track data to store the new data.
<b>Track Truncated</b>	A complete uploaded track will not fit in memory. The oldest track log points have been deleted.
<b>VNAV Cancelled</b>	VNAV function has been cancelled due to a change in the active route.
<b>Waypoint Already Exists</b>	A waypoint with the same name already exists.
<b>Waypoint Memory Full</b>	The unit has stored the maximum number of waypoints.

## AIRSPACE MESSAGES

Message	Comments
<b>Inside Airspace</b>	Inside the boundaries of the airspace.
<b>Airspace Near and Ahead</b>	Within two nautical miles of an airspace and the current course takes you inside the airspace.
<b>Airspace Ahead, Within 10 Minutes</b>	The projected course takes you inside an airspace within the next 10 minutes or less.
<b>Airspace Near, Within 2 nm</b>	Within two nautical miles of an airspace but not projected to enter it.

## DATA FIELD & NUMERIC DATA OPTIONS

Data Field/Numeric Data	Definition
<b>Accuracy</b>	The current accuracy of the GPS determined location.
<b>Altitude</b>	The current altitude in geometric height above Mean Sea Level (MSL).
<b>Bearing</b>	The compass direction from the present position to a destination waypoint.
<b>Course to Steer</b>	The recommended direction to steer in order to reduce cross-track error and return to the course line.
<b>Crosstrack Error</b>	The distance the aircraft is off a desired course in either direction, left or right.
<b>Desired Track</b>	The desired course between the active "from" and "to" waypoints.
<b>Distance (Destination)</b>	The distance to the destination waypoint in the Active Flight Plan
<b>Distance (Next)</b>	The distance to the next waypoint in the Active Flight Plan.
<b>En Route Safe Altitude</b>	The recommended minimum altitude within ten miles left or right of the desired course on a active flight plan or direct-to.

## DATA FIELD & NUMERIC DATA OPTIONS (CONT.)

Data Field/Numeric Data	Definition
<b>Flight Timer</b>	Total time in-flight (HH:MM).
<b>Fuel Timer</b>	Elapsed time since the Fuel Tank Reminder Alarm was last issued (HH:MM).
<b>Glide Ratio</b>	The estimated distance an aircraft will move forward for any given amount of lost altitude.
<b>Ground Speed</b>	The velocity that the aircraft is traveling relative to a ground position.
<b>Ground Track</b>	The direction of aircraft movement relative to a ground position.
<b>Minimum Safe Altitude</b>	Uses Grid MORAs to determine a safe altitude within ten miles of the aircraft's present position.
<b>Next Waypoint</b>	The next waypoint in the flight plan or direct-to route.
<b>Sunrise</b>	The time at which the sun rises on this day (current location).
<b>Sunset</b>	The time at which the sun sets on this day (current location).
<b>Estimated Time En Route (Destination)</b>	The estimated time it takes to reach the destination waypoint from the present position, based upon current ground speed.
<b>Estimated Time En Route (Next)</b>	The estimated time it takes to reach the next waypoint from the present position, based upon current ground speed.
<b>Estimated Time of Arrival (Destination)</b>	The estimated time at which the aircraft should reach the destination waypoint, based upon current speed and track.
<b>Estimated Time of Arrival (Next)</b>	The estimated time at which the aircraft should reach the next waypoint, based upon current speed and track.
<b>Estimated Time to VNAV</b>	The estimated time it takes to reach the VNAV waypoint from the present position, based upon current ground speed.



**DATA FIELD & NUMERIC DATA OPTIONS (CONT.)**

Data Field/Numeric Data	Definition
<b>Time of Day (Local)</b>	The current time and date in 12-hour or 24-hour format.
<b>Time (UTC)</b>	The current time and date in Universal (UTC) time.
<b>Vertical Speed</b>	The rate of climb or descent (GPS-derived).
<b>Vertical Speed Required</b>	The vertical speed necessary to descend/climb from a current position and altitude to the previously selected VNAV position and altitude, based upon current groundspeed.
<b>Weather (Altimeter)</b>	The altimeter setting at the nearest METAR reporting station.
<b>Weather (Dew Point)</b>	The dew point at the nearest weather reporting station.
<b>Weather (Rel. Humidity)</b>	The relative humidity at the nearest weather reporting station.
<b>Weather (Temperature)</b>	The temperature at the nearest weather reporting station.
<b>Weather (Wind)</b>	The wind speed and direction at the nearest weather reporting station.

**AURAL ALERTS**
**TRAFFIC**

- “Traffic”—TIS-A traffic alert received.
- “Traffic Not Available”—TIS-A service is not available or out of range.

**TERRAIN**

- “Five Hundred”—when the aircraft descends through 500 feet above the destination airport.

The following aural terrain alerts are issued when flight conditions meet parameters that are set within the software algorithms, and are dependant on the sensitivity level set in the Terrain Setup Menu.

Alert Severity	Terrain	Obstacle	Descent Rate
<b>Caution</b>	"caution, terrain" "caution, terrain ahead"	"caution, obstacle" "caution, obstacle ahead"	"caution, sink rate"
<b>Warning</b>	"terrain ahead! pull up!" "terrain! terrain! pull up! pull up!"	"obstacle ahead! pull up!" "obstacle! obstacle! pull up! pull up!"	"sink rate, pull up!" "pull up!"

### Aural Alerts

# APPENDIX B: ABNORMAL OPERATION

## LOSS OF GNSS POSITION

When the aera loses the GNSS signal for any reason, the following will occur:

- A blinking red question mark will appear over the airplane icon on the map.
- The 'Lost Satellite Reception' message will display.
- Any GNSS dependent data fields will not be available.

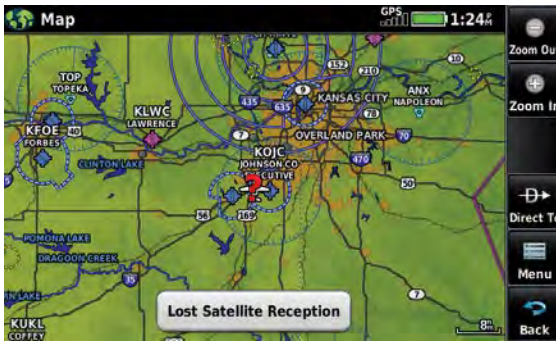

GNSS Signal Lost

## HAZARD DISPLAY WITH LOSS OF GNSS POSITION

If the Terrain function doesn't have at least a 3D fix (i.e. altitude unknown), a Red X will be displayed.



Terrain Red X

Overview

Navigation

Flight Planning

Hazard Avoidance

Additional Features

Appendices

Index

Blank Page

# APPENDIX C: MANAGING FILES AND DATABASES

## CONNECTING TO A COMPUTER

The aera can be connected to a computer using the included USB-PC Interface Cable to connect to a USB data port.



Mini-USB Connection

### Connecting the aera to a computer:

- 1) (Optional Step) Insert a memory card into the memory card slot. Press it in until it clicks.
- 2) Turn the unit on.
- 3) Connect the small end of the USB cable to the connector.
- 4) Connect the larger end of the USB cable to a USB port on the computer. The Mass Storage Icon appears on the screen, along with an icon indicating the usage mode. The aera and memory card appear as removable drives in My Computer in Windows and as mounted volumes on Mac computers.

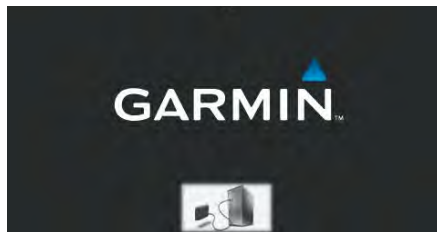

Mass Storage Icon

Mass Storage Mode

## MANAGING FILES



**NOTE:** The aera is not compatible with Windows95®, 98, Me, Windows NT®, and Mac® OS 10.3 and earlier.

Files can be stored in the aera internal memory or the optional memory card.

Supported File Types
GPX route files
GPI custom POI files from the POI Loader Application
Maps, routes, trip logs, and waypoints from MapSource®

### aera 660 File Types



## MAPSOURCE DETAILED MAPS

The included USB Interface Cable is used to transfer MapSource® CD-ROM data to the aera internal memory or optional MicroSD Card.

For compatible MapSource® products, refer to the Garmin web site at [www.garmin.com/cartography](http://www.garmin.com/cartography).

## TRANSFERRING FILES

### To transfer files:

- 1) Browse the computer for the file to copy.
- 2) Highlight the file, and select **Edit > Copy**.
- 3) Open the "Garmin" or memory card drive/volume.
- 4) Select **Edit > Paste**. The file appears in the list of files in the aera memory or on the memory card.
- 5) When finished transferring files, click  in the toolbar (system tray), or drag the volume icon to the  trash can on Mac computers.
- 6) Unplug the aera from the computer

## MicroSD™ CARD USE (OPTIONAL)

The aera uses an optional MicroSD™ Card for storing data.

### INSTALLING AND REMOVING MicroSD™ CARDS

Install the MicroSD Card in the slot located on the left side of the unit. Install or remove the MicroSD Card at any time, whether the unit is on or off.

You can load a variety of information to the aera internal memory or MicroSD Card, such as MapSource detailed maps in a MapSource program.



MicroSD Card Slot

#### Installing an MicroSD Card:

- 1) Firmly push the card into the unit. It is not necessary to force the card. The handle is still exposed when it is properly inserted.
- 2) The unit takes a few seconds to read the card. When the data card has been properly installed and accepted, a summary screen noting the card details appears. Touch to acknowledge.

If you insert an MicroSD Card and get a card format not recognized message, try removing the card and reinserting it. If the card is still not recognized, contact Garmin Product Support or your Garmin dealer.

## Removing an microSD Card:

- 1) Push the card into the unit until it stops.
- 2) Release the card. The card should eject for easy removal.
- 3) With the card ejected, pull the card out of the slot.

## DATABASE TYPES

---

The basemap database contains data for the topography and land features, such as rivers, lakes, and towns. It is updated only periodically, with no set schedule. There is no expiration date.

The terrain database contains the terrain mapping data. The database is updated periodically and has no expiration date.

The obstacle database contains data for obstacles, such as towers, that pose a potential hazard to aircraft. Obstacles 200 feet and higher are included in the obstacle database. It is very important to note that not all obstacles are necessarily charted and therefore may not be contained in the obstacle database. This database is updated on a 56-day cycle and does not expire.



---

**NOTE:** *The data contained in the terrain and obstacle databases comes from government agencies. Garmin accurately processes and cross-validates the data, but cannot guarantee the accuracy and completeness of the data.*

---

The Safe Taxi database contains detailed airport diagrams for selected airports. These diagrams aid in following ground control instructions by accurately displaying the aircraft position on the map in relation to taxiways, ramps, runways, terminals, and services. This database is updated on a 56-day cycle and does not expire.

## GARMIN AVIATION DATABASES

The Garmin database updates can be obtained via WiFi or by visiting the 'flyGarmin' website ([www.fly.garmin.com](http://www.fly.garmin.com)).

After the databases have been updated, check that the appropriate databases are initialized and displayed on the splash screen during power-up.



## AIRPORT DIRECTORY DATABASES

The AOPA Airport Directory provides data on airports and heliports throughout the U.S. and it is updated on a 56-day cycle. Detailed information for over 5,300 U.S. airports, along with the names and phone numbers of thousands of FBOs can be viewed. This service allows the pilot to plan an overnight, choose fuel stops, find ground transportation, etc.

Optional airport directory databases such as AC-U-KWIK are also supported. AC-U-KWIK provides complete listings of FBOs, charter companies, fuel suppliers, ground transportation, maintenance and catering services at public airports across the world.

## NAVIGATION DATABASE

The aera 660 includes an internal navigation database that provides location and facility information for thousands of airports, VORs, NDBs, and more. There are two navigation database products available: the Garmin Navigation database containing coverage for North America (expanded coverage is planned for the future), and the Jeppesen Navigation database containing coverage for the world, available in regionalized options. Database purchases are available online ([www.fly.garmin.com](http://www.fly.garmin.com)). However, once the databases are purchased, the ability to download and install databases is available from the aera 660 via WiFi.



---

**NOTE:** *Although the Garmin and Jeppesen Navigation Databases contain much of the same information, pilots may notice differences in behavior, nearest list functionality, airspace display, and map page display details due to data content variations.*

---

The following information is provided from the internal navigation database:

- \*Airport—identifier, facility name, city/state/country, latitude/longitude, field elevation, available fuel types, runway designations and layout, runway surface, runway length, runway width, runway lighting, communication frequencies, and published approaches.
- Weather—frequencies associated with an airport (ASOS, ATIS, and AWOS).

- \*VORs—identifier, facility name, city/state/country, location (latitude/longitude), frequency, service volume (high, low, terminal), and type (such as VOR-DME, TACAN, and VORTAC).
  - \*NDBs—identifier, facility name, city/state/country, location (latitude/longitude), and frequency.
  - Intersections—identifier, nearest VOR, radial and distance from nearest VOR, location (latitude/longitude), and region/country.
  - ARTCC—Air Route Traffic Control Centers.
  - Airspace—boundaries (Class B, Class C, Control Zones, SUAs, and MOAs), controlling agency, and vertical boundaries.
  - FSS—Flight Service Stations.
- \* Symbology used for NDBs, VORs, and airports is consistent with those used on a sectional chart.



**NOTE:** After performing a navigation database update, verify all flight plan(s) (routes) are current. If there is an obsolete aviation point in a saved route, the route is locked and unusable. A new route with current navigation database points will need to be created.

## DATABASE PURCHASE, INSTALLATION, AND UPDATES

Database purchases are available online ([www.fly.garmin.com](http://www.fly.garmin.com)). However, once the databases are purchased online, the ability to download and install databases is available from the aera 660 via WiFi.

### Purchasing/downloading/installing databases:

- 1) If necessary, from [www.fly.garmin.com](http://www.fly.garmin.com) register the unit and purchase the desired databases.
- 2) Connect to a WiFi network on the aera 660:
  - a) From the **Main Menu**, touch **Tools > Setup > Wi-Fi > On**.
  - b) Touch **Add Network**.
  - c) Touch the desired network to add.
  - d) If necessary, enter the password using the keypad and touch **Enter**.

- 3) From the **Main Menu**, touch **Tools > Downloads**.
- 4) If necessary, touch the desired database to 'Download' and touch the **Download** button.
- 5) If necessary, touch the desired database to 'Install' and touch the **Install** button.
- 6) If necessary, touch **Restart** to restart the unit after installations.

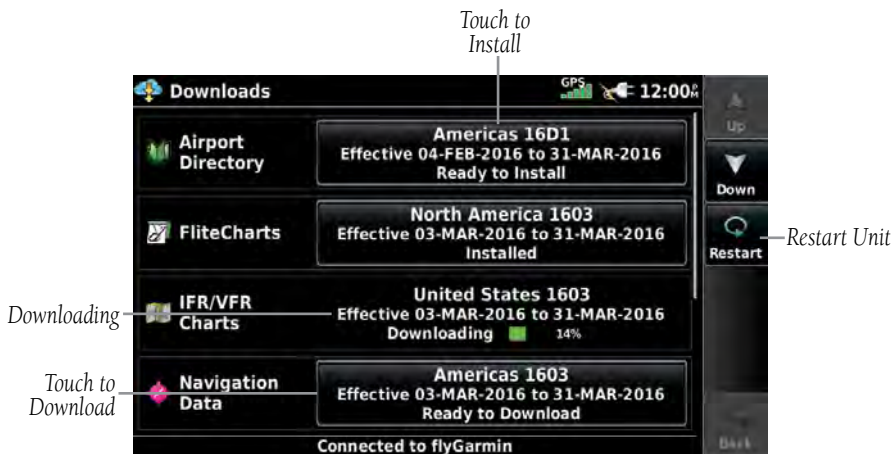

Downloads Page

Overview

Navigation

Flight Planning

Hazard Avoidance

Additional Features

Appendices

Index

Blank Page

## APPENDIX D: INSTALLATION AND INTERFACING

### MOUNTING THE aera IN THE AIRCRAFT

The aera yoke mount comes fully assembled as shown below. The yoke mount is designed to fit the majority of conventional aircraft yokes and center column controls.

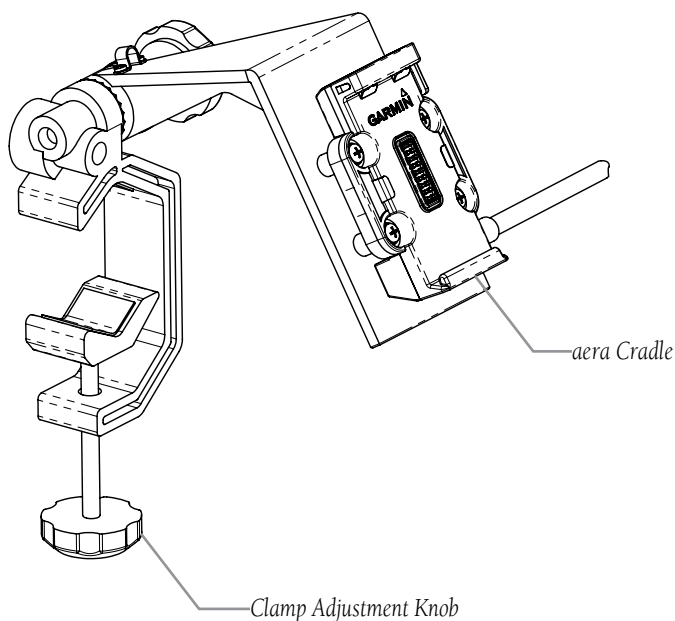

**WARNING:** It is the sole responsibility of the owner/operator of the aera to place this mount and secure the unit so that it will not interfere with the aircraft's operating controls and safety devices, or cause damage or personal injury in the event of an accident or turbulence. Do not mount the aera where the pilot or passengers are likely to impact it in an accident, collision, or turbulence. The mounting hardware provided by Garmin is not warranted against turbulence, collision damage, or related consequences.



**NOTE:** After installation, verify flight controls are free and clear per the flight manual of the applicable aircraft and that the aera yoke mount and wiring do not cause any interference with the flight controls.



**NOTE:** Readjust the position of the aera to provide the best view of the display screen as lighting conditions change.

### Attaching the yoke mount to the yoke shaft or control arm:

- 1) Open the clamp by turning the Clamp Adjustment Knob until it can be easily placed over the yoke shaft or control arm. Install the yoke mount as far from the panel as is practical.
- 2) When in place, tighten the Clamp Adjustment Knob to secure the yoke mount to the yoke shaft or control arm.
- 3) Loosen the Cradle Adjustment Knob, then orient the aera as desired.
- 4) Tighten the Cradle Adjustment Knob to hold the aera in place.
- 5) Connect power/data cables.

### Attaching the aera to the yoke mount:

- 1) Fit the bottom of the aera into the cradle.
- 2) Tilt the aera back until it snaps into place.

### Removing the aera from the yoke mount:

- 1) Press the Release Button on the side of the mount to release the aera.
- 2) Lift out the aera.

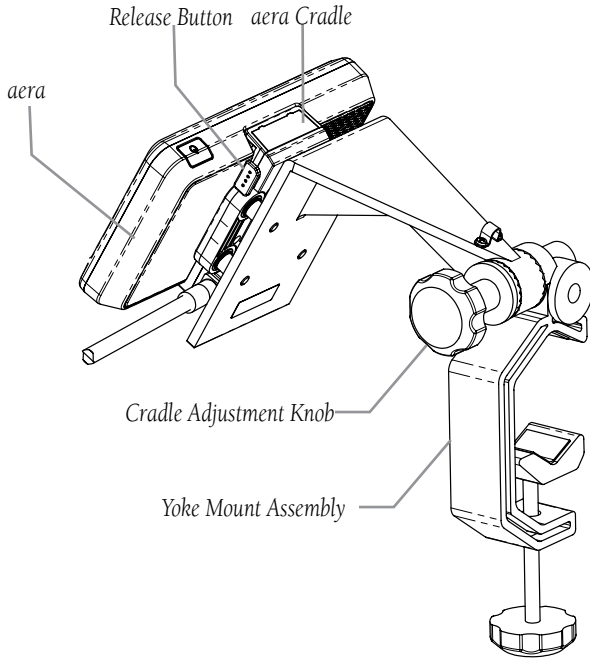

### Connecting the cables:

Make all applicable cable connections.

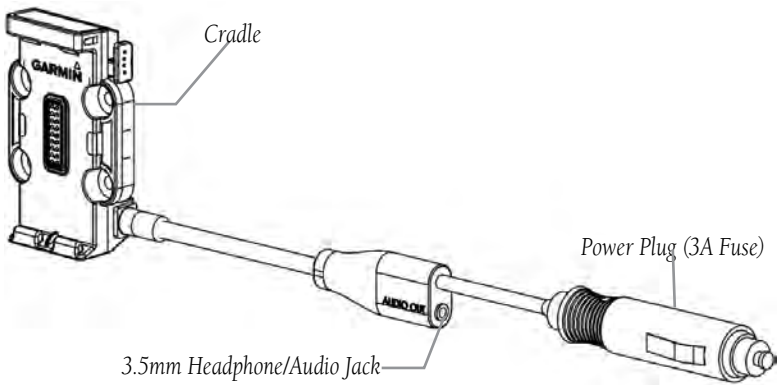

## Reconfiguring the yoke mount for center column yokes:

- 1) Loosen and remove the Cradle Adjustment Knob, spacer, and rubber washer.
- 2) Rotate the clamp assembly 90° so that the clamp opening faces away from you.
- 3) Secure the clamp assembly to the rest of the yoke mount using the Cradle Adjustment Knob, spacer, and rubber washer. Adjust the clamp angle before fully tightening the Cradle Adjustment Knob.

### Yoke Mount in Conventional Configuration

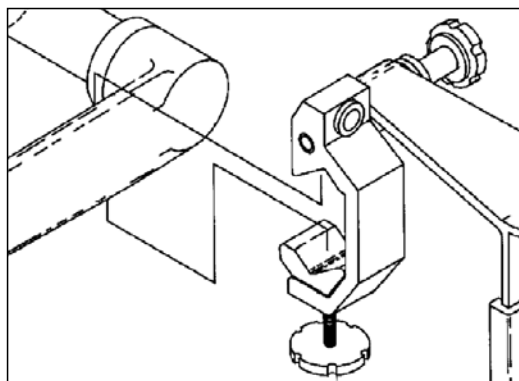
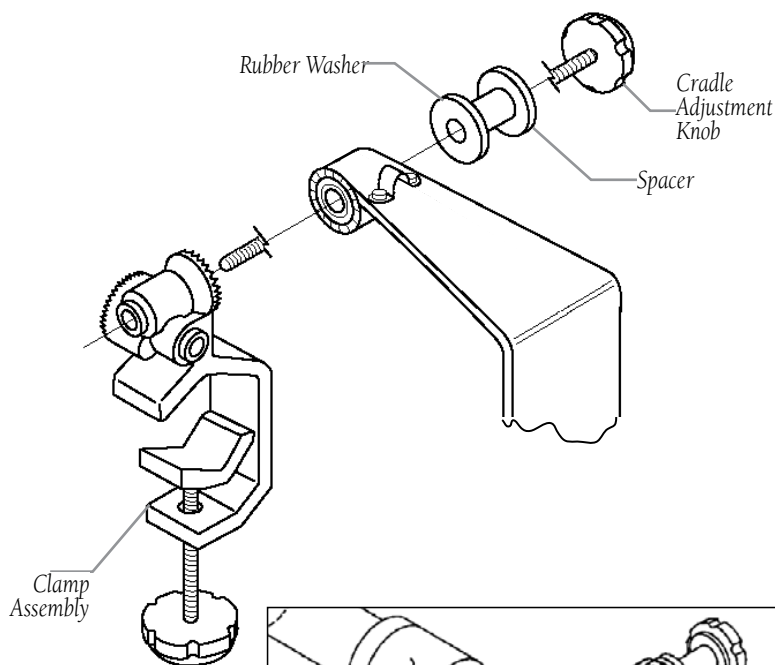

Yoke Mount in Forward-Facing Configuration



### Securing the cable on the top of the yoke mount:

- 1) Remove the screws securing the cable clamp.
- 2) Orient the cable and secure the clamp with the screws.

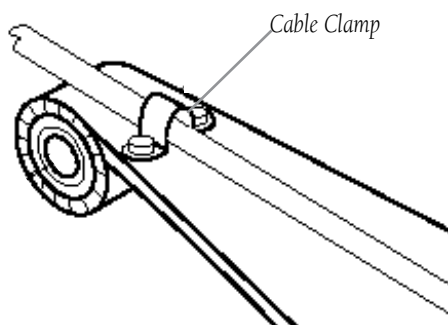

### Removing the yoke mount from the yoke shaft (or control arm):

- 1) Disconnect the cable connectors from the aircraft.
- 2) Loosen the clamp by turning the Clamp Adjustment Knob until the clamp assembly can be easily removed from the yoke shaft or control arm.

## CONNECTING TO A GARMIN VHF COMM RADIO

The aera can also output frequency data to a Garmin aviation radio. For additional information refer to the applicable installation manual. Currently the following models are supported:

- SL30 NAV/COMM
- SL40 COMM
- GTR 225
- GNC 255
- GTR 200



**NOTE:** For additional information refer to the SL30 NAV/COMM, SL40 COMM, GTR 225, GNC 255, or GTR 200 installation manual.



**CAUTION:** This interface does not have an FAA installation airworthiness approval. If any tuning or operational abnormalities are encountered with the SL30 nav/comm, SL40 comm, GTR 225, GNC 255, or GTR 200, disconnect the aera from the applicable tuning interface.

## Outputting frequency data to a SL40, SL30, GTR 200, GTR 225, or GNC 255 nav/comm radio:

- 1) Connect the aera to the applicable nav/comm radio using the Aviation Bare Wire Connector (optional accessory).

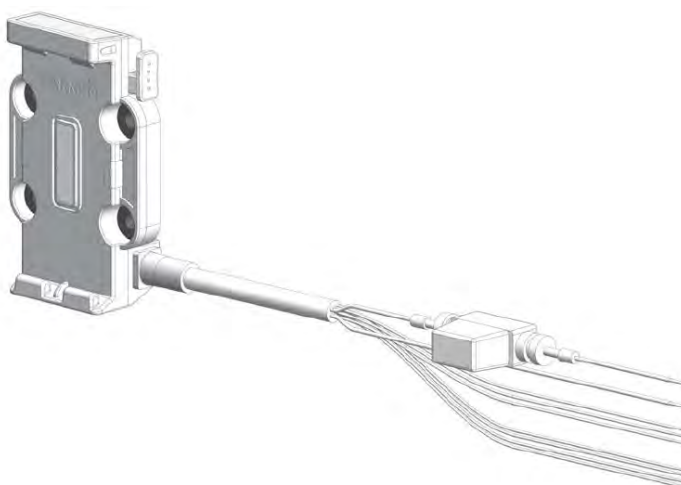

aera Aviation Bare Wire Connector

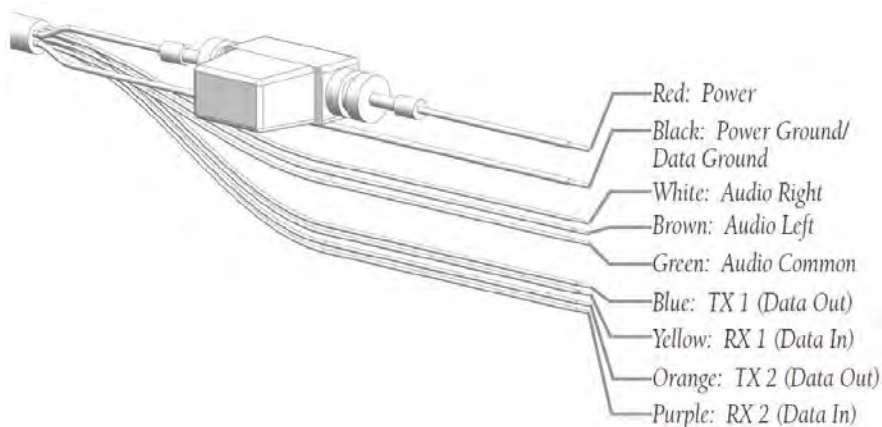

aera Aviation Bare Wire Connections

- 2) From the **Main Menu**, touch **Tools > Setup > Interface**.
- 3) Touch the **Serial Data Format** Button. A vertical list is displayed.

- 4) Touch '**Aviation In/NMEA & VHF Out**' or '**GTX TIS-A In/NMEA & VHF Out**'. These comm modes send both NMEA data and VHF frequency information.

The following features are now available on the radio:

- Remote frequency lists for departure, enroute, and arrival airports.
- Nearest VOR frequencies (SL30 only).

The aera can also directly tune a standby frequency.

### Selecting a standby comm frequency:

- 1) From the **Main Menu**, touch **Waypoint** > **Freq** Tab
- 2) Touch the desired frequency from the list. The frequency is now tuned in standby.

## INFORMATION ABOUT USB DRIVERS

When connecting the aera to a USB port, the computer prompts you to locate the destination of the drivers for the device. Only install the drivers once. After the drivers are installed, your computer always detects your aera when it is connected. USB driver updates can be found at [www.garmin.com](http://www.garmin.com).

## INTERFACING

The following formats are supported for connection of external devices: NMEA 0180, 0182, 0183 (versions 1.5, 2.0, 2.3, 3.01), ASCII Text Output, and Garmin proprietary formats for connecting to a Mode S transponder for TIS-A data, and to a Garmin aviation NAV/COM radio.

The following are the Approved Sentences for NMEA 0183, version 3.01 output: GPRMC, GPWPL, GPGGA, GPGSA, GPGSV, GPGLL, GPBOD, GPRTE, and GPWPL. The following are the Proprietary Sentences for NMEA 0183, version 3.01 output: PGRME, PGRMZ, PGRMM, and PGRMH.

Garmin's proprietary communication protocol is available from the Web site ([www.garmin.com](http://www.garmin.com)).

## GENERAL INTERFACE SETUP

The Interface Setup controls the input/output format used when connecting the unit to external devices.

### Selecting an interface:

- 1) From the **Main Menu**, touch **Tools** > **Setup** > **Interface**.
- 2) Touch **Serial Port 1** or **Serial Port 2**.
- 3) Touch **Serial Data Format**. A vertical list is displayed.
- 4) Touch the desired data format ('**Garmin Data Transfer**', '**NMEA Out**', '**Aviation In**', '**Aviation In/NMEA & VHF Out**', '**GTX TIS-A In**', '**GTX TIS-A In/NMEA & VHF Out**', or '**None**').

### Restoring interface defaults:

From the **Main Menu**, touch **Tools** > **Setup** > **Interface** > **Menu** > **Restore Default**.

## SERIAL DATA FORMATS

- **None**: Provides no interfacing capabilities.
- **NMEA Out**: Transmits NMEA position, velocity, and navigation data.
- **Aviation In**: The proprietary format used for connection to a Garmin panel-mounted GPS receiver. This eliminates the need to enter the destination on both units.
- **Aviation In/NMEA & VHF Out**: Receives aviation data and transmits out both NMEA data, at 9600 baud, and VHF frequency tuning information to a Garmin Nav/Comm radio.
- **GTX TIS-A In**: Receives TIS-A data from a Garmin Mode S transponder or other compatible device.
- **GTX TIS-A In/NMEA & VHF Out**: Receives TIS data and transmits out both NMEA data, at 9600 baud, and VHF frequency tuning information to a Garmin Nav/Comm radio.
- **Garmin Data Transfer**: The proprietary format used to exchange data with a PC, weather/traffic device, or another Garmin aera.

- **Connex 57600 Baud:** Connex datalink source. Used to receive ADS-B traffic and weather data. Supports GTX 345.

## ADVANCED NMEA OUTPUT SETUP

If interfacing the aera with another piece of equipment (such as an autopilot), the unit needs to be set to output NMEA data. If the NMEA output mode is set to 'Fast', the unit will output a minimum number of NMEA sentences at 1-second intervals. If the NMEA output is set to 'Normal', the unit will output a greater number NMEA sentences as 2-second intervals.

### Setting NMEA output mode:

- 1) From the **Main Menu**, touch **Tools > Setup > Interface**.
- 2) Touch **Serial Data Format**. A vertical list is displayed.
- 3) Touch **'NMEA Out'**.
- 4) Touch **NMEA Output Mode** to toggle between **'Normal'** or **'Fast'**.

NMEA Sentence Output:

- Normal Mode: GPRMB, GPRMC, GPGGA, GPGSA, GPGSV, GPGLL, GPBWC, GPVTG, GPXTE, GPBOD, GPRTE, GPWPL, GPAPB, PGRME, PGRMZ, PGRMM, and PGRMH.
- Fast Mode: GPRMB, GPRMC, PGRMZ, and PGRMH.

## CONNECTING TO A GTX 330 MODE S TRANSPONDER

To receive Mode S TIS-A traffic data from a GTX 330 transponder on your aera, connect an available RS-232 OUT wire on the transponder to the Data In wire on the aera. (You do not need to connect the transponder to the aera's Data Out wire.) Then, set the corresponding RS-232 output configuration on the transponder to REMOTE + TIS-A and set the aera's Serial Data Format to GTX TIS-A In or GTX TIS-A In/NMEA & VHF Out. For more information see the GTX 330 Transponder Installation Manual.

### Configuring TIS-A input:

- 1) Connect the aera to the GTX 330 using the Aviation Bare Wire Connector (optional accessory).
- 2) From the **Main Menu**, touch **Tools > Setup > Interface**.
- 3) Touch the **Serial Data Format** Button. A vertical list is displayed.

#### 4) Touch 'GTX TIS-A In' or 'GTX TIS-A In/NMEA & VHF Out'.

The TIS-A Status field indicates one of the following messages:

- Waiting For Data—searching for a valid TIS-A data stream.
- Data Available—receiving TIS-A data from the transponder.
- Data Unavailable—connection to transponder established, but TIS-A service is unavailable.
- Lost Connection—an error occurred or the connection to the transponder was lost.

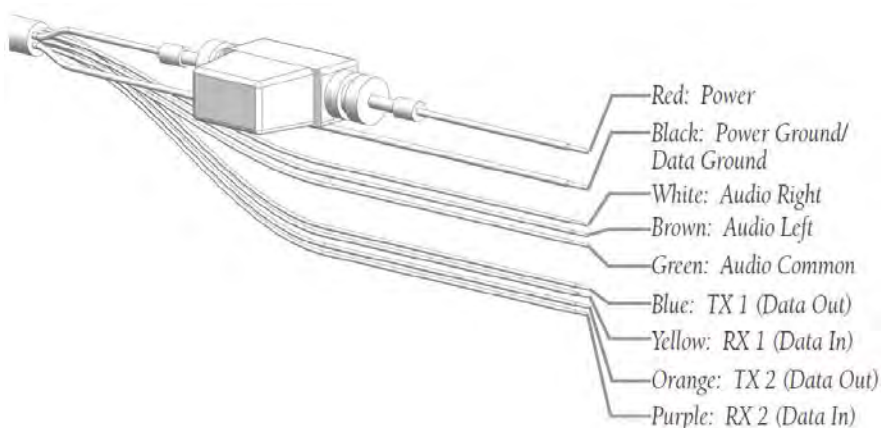

aera Aviation Bare Wire Connections

## CONNECTING TO A GDL 39/GDL 39R

To receive weather and traffic information from the GDL 39/GDL 39R, the GDL 39/GDL 39R must be connected to the aera using the 'GDL 39/GDL 39R Power/Data Cable to Aera 660 Series (P/N 010-12373-02) or through a GDL 39/GDL 39R bare wire cable (P/N 010-11686-40) installation. The aera must also be configured correctly to receive traffic and weather information from the GDL 39/GDL 39R as described below.

### Configuring aera for GDL 39/GDL 39R:

- 1) Connect the aera to the GDL 39/GDL 39R through the Power/Data Cable or bare wire cable. The GDL 39/39R may be connected to either serial (RS-232) port on the aera 660.
- 2) From the **Main Menu**, touch **Tools > Setup > Interface**.

- 3) Touch **Serial Port 1** or **Serial Port 2**.
- 4) Touch the 'Serial Data Format' data field button. A vertical list is displayed.
- 5) Touch '**Garmin Data Transfer**'. When recognized, the GDL 39/GDL 39R device and connections information is shown.
- 6) To view GDL 39/GDL 39R detailed connection/update status, from the **Main Menu**, touch **Tools > Data Link**.



**CAUTION:** *Never remove power from the aera or GDL 39/GDL 39R during a software update. Anytime the aera software is updated it may also contain firmware updates for products such as the GDL 39/GDL 39R. The aera software will update first, after the unit reboots it will update the firmware of a connected GDL 39/GDL 39R. You can view the GDL 39/GDL 39R update progress on the Data Link Information Page.*



GDL 39/GDL 39R Interface Setup

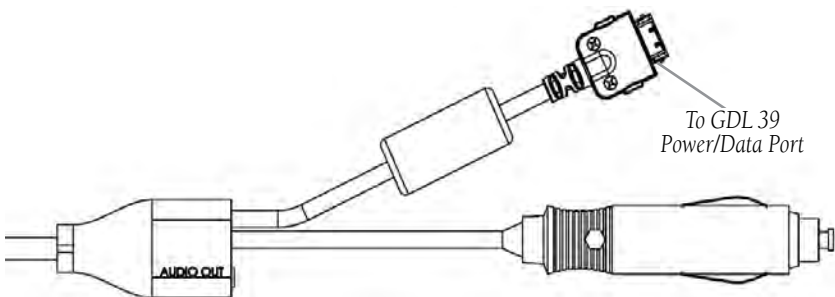

GDL 39 Power/Data Cable to Aera 660



**NOTE:** External GPS Antenna not required on either GDL 39 or GDL 39R when connected to aera 660.



**NOTE:** External UAT Antenna should be mounted on bottom of aircraft with 1 meter separation from COM and XPDR antennas.

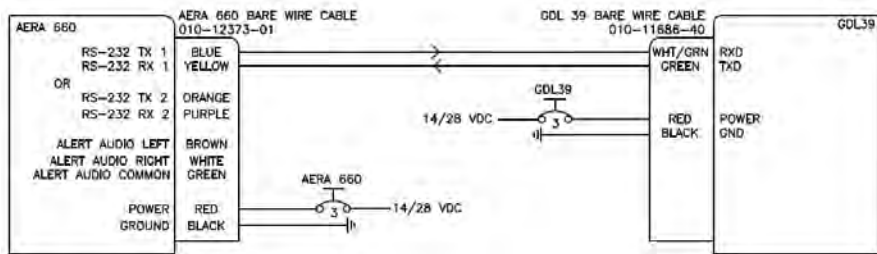

aera/GDL 39 Bare Wire Installation

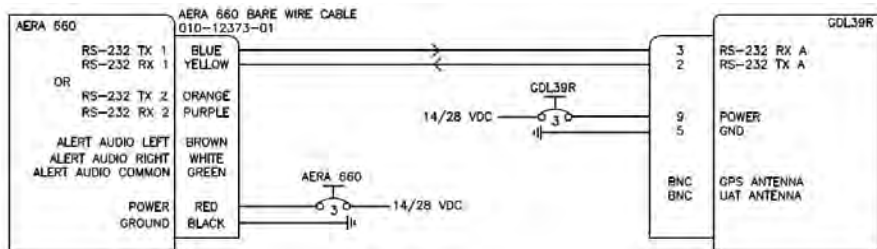

aera/GDL 39R Bare Wire Installation



## CONNECTING TO A GTX 345

To receive weather and traffic information from the GTX 345, the GTX must be connected to the aera through Bluetooth or the aera 660 bare wire cable (P/N 010-12373-01). The aera must also be configured correctly to receive traffic and weather information from the GTX 345 as described below.

### Configuring the aera 660 with GTX 345 using the RS-232 serial port:

- 1) Connect the aera to the GTX 345 through the bare wire cable.
- 2) From the **Main Menu**, touch **Tools > Setup > Interface**.
- 3) Touch the 'Serial Data Format' data field button. A vertical list is displayed.
- 4) Touch '**Connex 57600 Baud**'. When recognized, the GTX 345 device and connections information is shown.
- 5) From the GTX 345, press the **ON** and **ENT** Keys to enter setup mode.
- 6) Press the **FUNC** Key to reach the **RS-232 SETUP PAGE**.
- 7) Select **RS-232 CH CONNECTED TO AERA 660**.
- 8) Set input and output format to **CONNEXT FMT 1**.



**CAUTION:** *Never remove power from the aera or GTX 345 during a software update. Anytime the aera software is updated it may also contain firmware updates for products such as the GTX 345. The aera software will update first, after the unit reboots it will update the firmware of a connected GTX 345. You can view the GTX 345 update progress on the Data Link Information Page.*



**NOTE:** *External UAT Antenna should be mounted on bottom of aircraft with 1 meter separation from COM and XPDR antennas.*

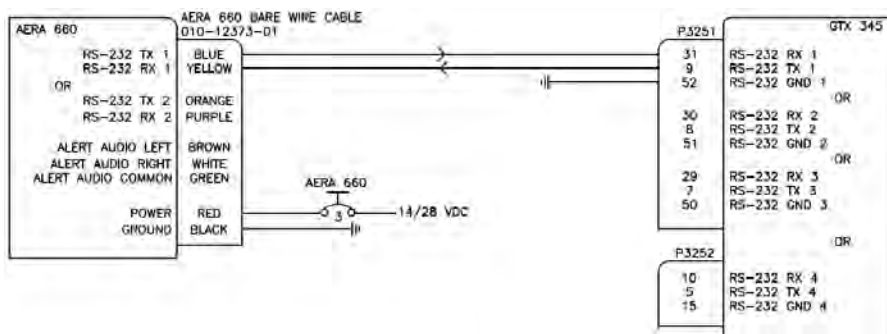

### uera/GTX 345 Bare Wire Installation

#### Connecting/Pairing GTX 345 via Bluetooth:

- 1) Ensure the GTX 345 is turned on. From the **Main Menu**, touch **Tools** > **Setup** > **Bluetooth** > **On**.
- 2) Touch **Not Paired** next to the GTX Device. A Bluetooth Passkey window will open.
- 3) Touch **OK**. The GTX 345 is now connected.



**NOTE:** Only one Bluetooth connection is allowed at a time.

#### USING AN EXTERNAL GPS ANTENNA (OPTIONAL)

The optional GA25 external antenna can be used. Connect the antenna to the connector located on the left side of the unit.



External Antenna Connector

## APPENDIX E: BATTERY AND CARE INFORMATION

### BATTERY INFORMATION

The aera contains a user-replaceable, lithium-ion battery. To maximize the lifetime of the battery, do not leave the aera in direct sunlight, and avoid prolonged exposure to excessive heat.

The  battery icon in the top right of the screen indicates the status of the aera battery. To increase the accuracy of the battery gauge, fully discharge the battery and fully charge it. Do not unplug the aera until it is fully charged.

#### MAXIMIZING THE BATTERY LIFE

- Turn down the backlight (refer to the 'System Settings' chapter of this section).
- Do not leave the unit in direct sunlight, in a cool (not freezing) place. When storing the unit, store within the following temperature ranges: safe storage -15° to 55° C, or long term storage 0° to 25° C.
- Do not operate the unit outside of the following temperature range: -15° to 55° C.
- Avoid prolonged exposure to excessive heat.

#### REPLACING THE BATTERY IN THE AERA

To replace the battery, use a Garmin lithium-ion battery 010-11654-03. Purchase a replacement battery at <http://buy.garmin.com>. Contact the local waste disposal department for information about properly disposing of the battery.

### CHANGING THE FUSE

If the unit does not charge, the fuse may need to be replaced.

- 1) Unscrew the round end piece, and remove it.
- 2) Remove the fuse (glass and silver cylinder), and replace with a 3A fast-blow fuse.
- 3) Ensure that the silver tip is placed in the end piece. Screw on the end piece.

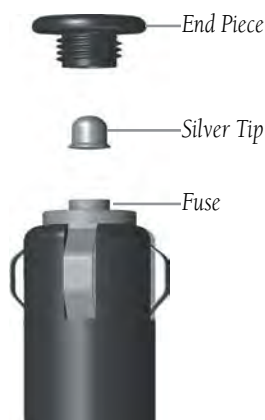

## CLEANING THE CASING

---

The aera is constructed of high-quality materials and does not require user maintenance other than cleaning. Clean the outer casing (not the touchscreen) using a cloth dampened with a mild detergent solution, and then wipe dry. Avoid chemical cleaners and solvents that can damage plastic components.

## CLEANING THE TOUCHSCREEN

---

The aera 660 display uses a lens coated with a special coating that is very sensitive to abrasive cleaners. **AVOID CHEMICAL CLEANERS AND SOLVENTS THAT WILL HARM THE SPECIAL COATING.** It is very important when cleaning the touchscreen to use a clean, lint-free cloth (lightly dampened with water, if necessary).

## PROTECTING THE UNIT

---

- Do not store the aera where prolonged exposure to extreme temperature can occur.
- Though a PDA stylus can be used to operate the touchscreen, never attempt this while operating an aircraft. Never use a hard or sharp object to operate the touchscreen.

## AVOIDING THEFT

---

- Remove the unit from sight when not in use.
- Do not keep the unit in the glove compartment.
- Register the product at <http://my.garmin.com>.

Overview

Navigation

Flight Planning

Hazard Avoidance

Additional Features

Appendices

Index

Blank Page

## APPENDIX F: GENERAL TIS-A INFORMATION



**NOTE:** Aircraft without an operational transponder are invisible to TIS-A.



**WARNING:** Do not rely solely upon the display of traffic information for collision avoidance maneuvering. The traffic display does not provide collision avoidance resolution advisories and does not, under any circumstances or conditions, relieve the pilot's responsibility to see and avoid other aircraft.



**WARNING:** Do not rely solely upon the display of traffic information to accurately depict all of the traffic within range of the aircraft. Due to lack of equipment, poor signal reception, and/or inaccurate information from aircraft or ground stations, traffic may be present that is not represented on the display.

The Traffic Information Service (TIS-A) provides traffic advisory information to non-TAS/TCAS-equipped aircraft. TIS-A is a ground-based service providing the relative locations of all ATCRBS (Air Traffic Control Radar Beacon System) Mode-A and Mode-C transponder equipped aircraft within a specified service volume. The TIS-A ground sensor uses real-time track reports to generate traffic notification. The aera displays TIS-A traffic information on the Navigation Map. Surveillance data includes all transponder-equipped aircraft within the coverage volume. The aera displays up to eight traffic targets within a 7.5-nm radius, from 3,000 feet below, to 3,500 feet above the requesting aircraft.

### TIS-A VS. TAS/TCAS

The main difference between the Traffic Information System (TIS-A) and Traffic Advisory (TAS) or Traffic Collision Avoidance Systems (TCAS) is the source of surveillance data. TAS/TCAS uses an airborne interrogator with a half-second update rate, while TIS-A utilizes the terminal Mode-S ground interrogator and accompanying data link to provide a five-second update rate. TIS-A and TAS/TCAS have similar ranges.

## TIS-A LIMITATIONS

TIS-A relies on surveillance of the Mode-S radar system, which is a “secondary surveillance” radar system similar to that used by ATCRBS. Many limitations are inherent in secondary radar surveillance. Information provided by TIS-A is neither better nor more accurate than the information used by ATC. TIS-A is intended only to assist in visual acquisition of other aircraft in visual meteorological conditions (VMC). While TIS-A is a useful aid for visual traffic avoidance, system limitations must be considered to ensure proper use. No recommended avoidance maneuvers are given, nor authorized, as a direct result of a TIS-A intruder display or TIS-A advisory.

- TIS-A operation may be intermittent during turns or other maneuvering.
- TIS-A is dependent on two-way, line-of-sight communications between the aircraft and the Mode-S radar antenna. Whenever the structure of the aircraft comes between the transponder antenna and the ground-based radar antenna, the signal may be temporarily interrupted.



---

**NOTE:** Refer to the TIS-A Limitations section of the Aeronautical Information Manual (AIM) for a more comprehensive explanation of limitations and anomalies associated with TIS-A.

---



---

**NOTE:** TIS-A is unavailable at low altitudes in many areas of the United States. This is often the case in mountainous regions.

---



---

**NOTE:** Garmin is not responsible for Mode S geographical coverage. Operation of the ground stations is the responsibility of the FAA. Refer to the AIM for a Terminal Mode S radar site map.

---



TIS-A information is collected during a single radar sweep. Collected information is then sent through the Mode S uplink on the next radar sweep. Because of this, the surveillance information is approximately five seconds old. TIS-A ground station tracking software uses prediction algorithms to compensate for this delay. These algorithms use track history data to calculate expected intruder positions consistent with the time of display. Occasionally, aircraft maneuvering may cause variations in this calculation and create slight errors on the Navigation Map which affect relative bearing information and the target track vector and may delay display of the intruder information. However, intruder distance and altitude typically remain relatively accurate and may be used to assist in spotting traffic. The following errors are common examples:

- When the client or intruder aircraft maneuvers excessively or abruptly, the tracking algorithm may report incorrect horizontal position until the maneuvering aircraft stabilizes.
- When a rapidly closing intruder is on a course that intercepts the client aircraft course at a shallow angle (either overtaking or head-on) and either aircraft abruptly changes course within 0.25 nm, TIS-A may display the intruder aircraft on the incorrect side of the client aircraft.

These are rare occurrences and are typically resolved within a few radar sweeps once the client/intruder aircraft course stabilizes.

Pilots using TIS-A can provide valuable assistance in the correction of malfunctions by reporting observations of undesirable performance. Reports should identify the time of observation, location, type and identity of the aircraft, and describe the condition observed. Reports should also include the type of transponder and transponder software version. Since TIS-A performance is monitored by maintenance personnel, not ATC, malfunctions should be reported in the following ways:

- By telephone to the nearest Flight Service Station (FSS) facility
- By FAA Form 8000-7, Safety Improvement Report (postage-paid card can be obtained at FAA FSSs, General Aviation District Offices, Flight Standards District Offices, and General Aviation Fixed Base Operators)

Overview

Navigation

Flight Planning

Hazard Avoidance

Additional Features

Appendices

Index

Blank Page

# APPENDIX G: UTILITIES

## FLIGHT LOG

The Flight Log shows a list of any recorded flights, including date, route of flight, and flight time. The aera saves up to 50 recorded flights. Entries on this list are automatically created for each flight.

Recording begins when your speed exceeds 30 knots and you gain 250 feet of altitude. If you land and groundspeed drops below 30 knots, the flight entry is saved and a new entry is recorded when you depart the airport. A touch-and-go or brief stop of less than 10 minutes appends to the current flight record, rather than starting a new entry.

### VIEWING THE FLIGHT LOG

Select any listed entry in the log to view additional information, including a map displaying the actual path flown.

#### Viewing details for a flight:

- 1) From the **Main Menu**, touch **Tools > Flight Log**.
- 2) Touch the desired flight log. Route, date, hours, distance, and the flight path are displayed.



Flight Log

## DELETING FLIGHT RECORDS

You can delete the highlighted flight record or delete all flight records from the Flight Log.

### Deleting flight records:

- 1) From the **Main Menu**, touch **Tools** > **Flight Log**.
- 2) Touch the desired flight log (if applicable).
- 3) Touch **Menu** > **Delete Flight** > **Yes**.

## TRACK LOG

The aera draws an electronic breadcrumb trail or “track log” on the Navigation Map. The track log contains points along its path, including time, and location for each point.

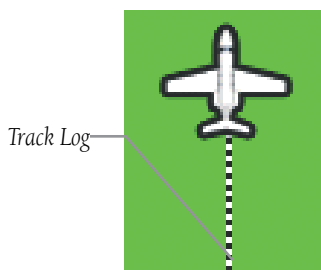

Track Log (Navigation Map)

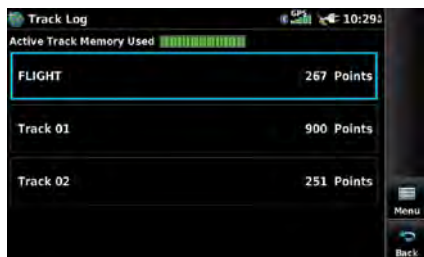

Track Log

The track log starts recording as soon as the aera gets a location fix. For the best results, clear the track log before each flight.

The percentage of memory used by the current track log appears at the top of the Track Log Window. After the track log is cleared, it shows zero percent. When the screen reaches 100%, the most recent track points start to overwrite the least recent track points (if 'Wrap' is selected in the Record Mode Field). To avoid losing track points, save the track log when it approaches the 99% mark.

The Save feature allows storage of up to 15 track logs.

### Showing/hiding the track log on the Navigation Map:

- 1) From the **Main Menu**, touch **Map > Menu > Set Up Map**.
- 2) Touch the Dedicated Page Icon and touch the **Line Group**.
- 3) Touch **Track Log** button and touch **Show** or **Hide**.

### Changing track log settings:

- 1) From the **Main Menu**, touch **Map > Menu > Set Up Map**.
- 2) Touch the Dedicated Page Icon and touch the **Line Group**.
- 3) Touch the **Track Log Record Mode** button and touch **Off**, **Fill**, or **Wrap**.
- 4) Touch the **Track Log Interval** button and touch **Auto**, **Distance**, or **Time**.
- 5) Touch the **Track Log Color** button and touch the desired color from the list.

Track Log settings are also available from the Track Log Option Menu

- Track Log—Select '**Show**' or '**Hide**' to display/remove the track log on the map.
- Track Record Mode—'**Off**' disables track log recording. '**Fill**' records a track log until the track log is full (100%). '**Wrap**' records over the oldest tracks when the track log reaches 100%.
- Track Interval—'**Distance**' records track points after a specified distance has been traveled. '**Time**' creates track points after a specified time has elapsed. '**Automatic**' saves points that occur after changes in navigation.
- Track Color—Select a color for the track when it appears on the map.

### Clearing the track log:

- 1) From the **Main Menu**, touch **Tools > Track Log**.
- 2) Touch the desired track log (if applicable).
- 3) Touch **Menu**.
- 4) Touch **Clear Active Track** or **Delete All Saved Tracks**.
- 5) Touch **Yes**.

### Saving a track log:

- 1) From the **Main Menu**, touch **Tools > Track Log > Menu > Save Active Track**.
- 2) Touch the **Save** button and touch '**Entire Active Track**', '**Past 24 Hours**', '**Past 7 Days**', '**Selected Flight**', or '**Specific Dates**'.
- 3) Enter the Selected Flight or Specified Dates (if applicable) and touch **OK**.

### Editing a track log:

- 1) From the **Main Menu**, touch **Tools > Track Log**.
- 2) Touch the desired track log.
- 3) Touch desired field to edit (**Track Name**, **Show On Map**, or **Color**).

## TRACK VECTOR

The aera draws an electronic “Track Vector” on the Navigation Map. The Track Vector can be set to time or distance.

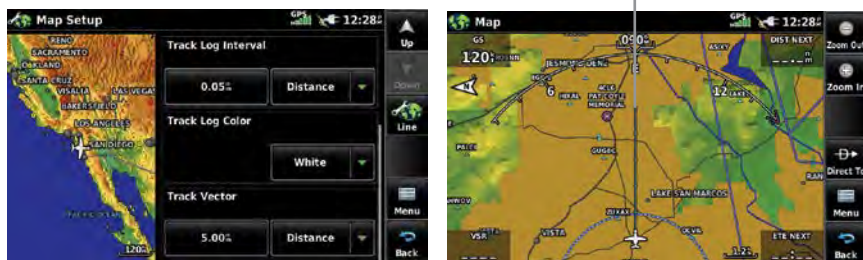

Track Vector Setup

**Changing the track vector settings on the Navigation Map:**

- 1) From the **Main Menu**, touch **Map > Menu > Set Up Map**.
- 2) Touch the Dedicated Page Icon and touch the **'Line'** Group.
- 3) Touch the **Track Vector** button and touch **Off, Distance, or Time**.
- 4) If **Distance** is selected, use the keypad to enter the desired distance and touch **Enter**.
- 5) If **Time** is selected, use the **+ / -** buttons to select the desired time.

**E6B CALCULATOR**

The E6B Calculator calculates Density Altitude, True Airspeed, Tail Wind, Wind From, and Wind Speed, based on information entered.

**Accessing the E6B calculator:**

From the **Main Menu**, touch **Tools > E6B**.

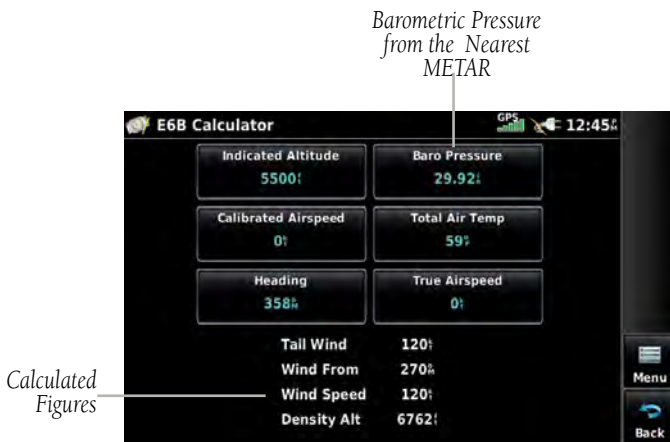

**E6B Calculator**

- **Indicated Altitude**—required entry for density altitude/true airspeed calculation. Enter the aircraft's altimeter reading.
- **Baro Pressure**—enter the current barometric pressure.

- **Calibrated Airspeed**— required entry for density altitude/true airspeed calculation. Enter the aircraft's airspeed indicator value.
- **Total Air Temp**— required entry for density altitude/true airspeed calculation. Total Air Temperature (TAT) is the temperature of the air including the heating effect caused by speed. The temperature reading on a standard outside air temperature gauge found on most piston aircraft is TAT.
- **Heading**— required entry for winds aloft calculation. Use heading from the aircraft's heading indicator or directional gyro.
- **True Airspeed**— (calculated or user-entered figure) determined from entry of calibrated airspeed, barometric pressure, and total air temperature. This can also be entered directly for winds aloft calculations.
- **Tail Wind**— (calculated figure) determined from entry of heading and true airspeed.
- **Wind From**—(calculated figure) determined from entry of heading and true airspeed.
- **Wind Speed**—(calculated figure) determined from entry of heading and true airspeed.
- **Density Altitude**— (calculated figure) determined from entry of indicated altitude, barometric pressure and total air temperature.

### Calculating true airspeed and density altitude:

- 1) From the **Main Menu**, touch **Tools** > **E6B**, enter the altitude shown on the altimeter into the 'Indicated Altitude' field.
- 2) Repeat for 'Calibrated Airspeed', 'Baro Pressure', and 'Total Air Temperature' fields. (For Calibrated Airspeed, use the speed shown on the airspeed indicator. Use the current altimeter setting for Baro Pressure. Total Air Temperature is the temperature of the outside air including the heating effect caused by speed. For most aircraft, this is the temperature reading on a standard outside air temperature gauge.) The calculated figures for True Airspeed and Density Altitude are shown in the designated fields.



**Calculating winds aloft:**

- 1) From the **Main Menu**, touch **Tools > E6B**, calculate or enter the true airspeed into the 'True Airspeed' field.
- 2) Enter the aircraft heading shown on the directional gyro or compass into the 'Heading' field. Tail Wind, Wind From, and Wind Speed are calculated.



**NOTE:** If True North is selected as the heading reference, a heading referenced to True North must be used to calculate winds accurately.

**Restoring E6B calculator defaults:**

From the **Main Menu**, touch **Tools > E6B > Menu > Restore Default**.

**AIRCRAFT PROFILE**

The Aircraft Profile allows the pilot to select cruising speed, maximum speed, fuel flow, and map symbol.

The maximum speed is used to define the range for airspeed on the 3D Vision Page and is automatically updated if you exceed this figure.

**Accessing the aircraft profile:**

From the **Main Menu**, touch **Tools > Profile**



**Aircraft Profile**

### Entering an aircraft profile:

- 1) From the **Main Menu**, touch **Tools > Profile**
- 2) Touch the **Aircraft Identifier** button and enter the aircraft identifier using the keypad. Touch **Enter**.
- 3) Touch the **Map Symbol** button and touch the desired symbol from the list.
- 4) Touch the **Aircraft Fuel Type** button and touch the desired fuel type from the list.
- 5) Touch the **Flight Planning Fuel Flow** button and enter the fuel flow using the keypad. Touch **Enter**.
- 6) Touch the **Flight Planning Cruise Speed** button and enter the cruise speed using the keypad. Touch **Enter**.
- 7) Touch the **Maximum Aircraft Speed** button and enter the max speed using the keypad. Touch **Enter**.

## WEIGHT & BALANCE

Weight & Balance may be used during pre-flight preparations to verify the weight and balance conditions of the aircraft. By entering the weight and arm values, the aera can calculate the total weight, moment, and center of gravity (CG).

Before entering the various figures, the empty weight of the airplane and the arm (or "station") for each weight should be determined. These figures should be determined using the pilot's operating handbook for the airplane, which also notes the weight limitations and fore/aft CG limits. Compare those figures to the values calculated by the aera.

### To perform weight and balance calculations:

- 1) From the **Main Menu**, touch **Tools > Weight & Balance**
- 2) Touch the fields to enter the desired weights and arms (or "stations"). The calculated moment, weight, and CG figures appear at the bottom of the screen. Keep in mind that the "Aircraft" (empty weight/arm) figures must be entered as a reference to calculate a valid moment, weight, and CG.
- 3) To empty the aircraft, touch **Menu > Empty Aircraft**.



**NOTE:** This information is only for flight planning purposes. Consult the aircraft's pilot operating handbook for the official weight and balance data.



Weight & Balance

## PROXIMITY WAYPOINTS

The Proximity Waypoints allows the pilot to define an alarm circle around a waypoint location.



Proximity Waypoints

### Defining proximity waypoints:

- 1) From the **Main Menu**, touch **Tools > User Waypoint > Proximity Tab > Menu > New Proximity Waypoint**.
- 2) Touch **Use Identifier** or **Use Map**.
- 3) Enter the desired identifier or pan the map.
- 4) Touch the newly created Proximity Waypoint and touch **Edit Radius**.
- 5) Enter the desired radius using the keypad and touch **Enter**.

## Setting up and customizing proximity waypoints for the navigation map:

From the **Main Menu**, touch **Tools** > **User Waypoint** > **Proximity Tab** > **Menu** > **Enable/Disable Proximity Alarms**.

**Or:**











- 1) From the **Main Menu**, touch **Map** > **Menu** > **Set Up Map**.
- 2) Touch the Dedicated Page Icon and touch the **Point** Group.
- 3) Touch the **Proximity Circle** button and touch the desired settings ('**Off**', '**Auto**', or Range Settings).

## Deleting proximity waypoints:







- 1) From the **Main Menu**, touch **Tools** > **User Waypoint** > **Proximity Tab**.
    - a) Touch the desired proximity waypoint.
    - b) Touch **Delete Proximity Waypoint**.
- Or:**
- a) Touch **Menu**.
  - b) Touch **Delete All**.
- 2) Touch **Yes**.

# APPENDIX H: DISPLAY SYMBOLS

## VFR SYMBOLS

Item	Symbol
Unknown	
Non-towered, Non-serviced	
Towered, Non-serviced	
Non-towered, Serviced	
Towered, Serviced	
Soft Surface, Non-serviced	
Soft Surface, Serviced	
Soft Surface, Private	
Paved, Private	
Seaplane Base	
Heliport	

**Americas/Pacific Database Airports**

Item	Symbol
Civilian, Non-serviced	
Military, Non-serviced	
Civilian, Serviced	
Military, Serviced	
Civilian, Soft/Unknown Surface, Non-serviced	
Civilian, Soft/Unknown Surface, Serviced	

**Atlantic Database Airports**

Overview

Navigation









Flight Planning

Hazard Avoidance

Additional Features

Appendices

Index



Item	Symbol
Intersection	
Visual Reporting Point	
LOM (compass locator at outer marker)	
NDB (non-directional radio beacon)	
VOR	
VOR/DME	
ILS/DME or DME only	
VORTAC	
TACAN	

Nav aids



Item	Symbol
Interstate Highway	
US Highway	
State Highway	
National Highway	
Small City	
Medium City	
Large City	

Miscellaneous











## IFR SYMBOLS

Item	Symbol
VFR, Soft/unknown Surface, Non-serviced	
VFR, Soft/unknown Surface, Serviced	









Atlantic Database Airports

Item	Symbol
Low-Altitude	
High-Altitude	

Airways

Item	Symbol
Unknown	
VFR Airport, Non-serviced	
IFR Airport, Non-serviced	
VFR Airport, Serviced	
IFR Airport, Serviced	
VFR, Soft Surface, Non-serviced	
VFR, Soft Surface, Serviced	
VFR, Soft Surface, Private	
VFR, Paved, Private	
VFR Seaplane Base	
VFR Heliport	

**Americas/Pacific Database Airports**

Item	Symbol
Intersection	
LOM (compass locator at outer marker)	
NDB (non-directional radio beacon)	
VOR	
VOR/DME	
ILS/DME or DME Only	
VORTAC	
TACAN	

**Nav aids**

# AIRSPACE SYMBOLS



Item	Symbol
Class B, Class E, CTA	
Class A, Class C, TMA	
Class D	
Mode C Veil	
TRSA	
MOA	
Danger, Alert, or Training Area	
Restricted, Prohibited, or Warning Area	
Radar Area	
ATZ, TIZ	
MATZ	
ADIZ	
Misc/Unknown	

VFR Americas/Pacific Database

Item	Symbol
Class B, Class E, CTA	
Class A, Class C, TMA, TRSA	
Class D	
MOA	
Danger, Alert, or Training Area	
Restricted, Prohibited, or Warning Area	
Radar Area	
ATZ, TIZ	
Misc/Unknown	

IFR Americas/Pacific Database



Item	Symbol
Danger or Alert Area	
Restricted, Prohibited, or Warning Area	
Training Area	

**VFR Atlantic Database Exceptions**

Item	Symbol
Training Area	

**IFR Atlantic Database Exceptions**

Overview

Navigation

Flight Planning

Hazard Avoidance

Additional Features

Appendices

Index

Blank Page

# APPENDIX I: MAP DATUM AND LOCATION FORMATS

## MAP DATUMS

---

A datum is a mathematical model of the Earth that approximates the shape of the Earth and enables calculations to be carried out in a consistent and accurate manner. The datum is physically represented by a framework of ground monuments (such as trig. stations) whose locations have been accurately measured and calculated on this reference surface. Lines of latitude and longitude on a chart are referenced to a specific map datum. Every chart has a map datum reference and the aera can be set to match most of those commonly used.

## LOCATION FORMATS

---

Your current location can be viewed on the GPS in the form of coordinates. Since different charts use different location formats, Garmin GPS units allow you to choose the correct coordinate system for the type of chart you are using. The most common format is latitude and longitude, which is used by all Garmin units. You can change the location format to use with other coordinate systems. Several other grids, including a user-definable grid (for the advanced user), are available.

Overview

Navigation

Flight Planning

Hazard Avoidance

Additional Features

Appendices

Index

Blank Page

## APPENDIX J: GLOSSARY

ADIZ	Air Defense Identification Zone
ADS-B	Automatic Dependant Surveillance -Broadcast
ADS-B In	Ability to receive ADS-B information from other aircraft and Ground Based Transceivers (GBTs)
ADS-B Out	Ability to transmit ADS-B data on 1090 ES or 978 MHz
ADS-B Participating Aircraft	An aircraft that has both ADS-B In and ADS-B Out capabilities.
ADS-R	Automatic Dependent Surveillance-Rebroadcast
AGL	Above Ground Level
AIRMET	Airman’s Meteorological Information
ARTCC	Air Route Traffic Control Center
ASOS	Automated Surface Observing System
ATC	Air Traffic Control
ATIS	Automatic Terminal Information Service
AWOS	Automated Weather Observing System
Bearing	The compass direction from the present position to a destination waypoint.
°C	degrees Celsius
Calibrated Airspeed	Indicated airspeed corrected for installation and instrument errors.
cm	centimeter
COM	communication radio
Course	The line between two points to be followed by the aircraft.
Course to Steer	The recommended direction to steer in order to reduce course error or stay on course. Provides the most efficient heading to get back to the desired course and proceed along the flight plan.

Crosstrack Error The distance the aircraft is off a desired course in either direction, left or right.

dBZ decibels 'Z' (radar return)

deg degree

Desired Track The desired course between the active "from" and "to" waypoints.

DIS distance

Distance The 'great circle' distance from the present position to a destination waypoint.

DME Distance Measuring Equipment

DTK Desired Track

Enroute Safe Altitude The recommended minimum altitude within ten miles left or right of the desired course on an active flight plan or direct-to.

ESA Enroute Safe Altitude

Estimated Time of Arrival The estimated time at which the aircraft should reach the destination waypoint, based upon current speed and track.

Estimated Time Enroute The estimated time it takes to reach the destination waypoint from the present position, based upon current ground speed.

ETA Estimated Time of Arrival

ETE Estimated Time Enroute

°F degrees Fahrenheit

FAA Federal Aviation Administration

FAF Final Approach Fix

FCC Federal Communication Commission

FIS-B Flight Information Service-Broadcast

fpm feet per minute

FSS	Flight Service Station
ft	foot/feet
gal	gallon(s)
Glide Ratio, G/R	The estimated distance an aircraft will move forward for any given amount of lost altitude.
gph	gallons per hour
GPS	Global Positioning System
Grid MORA	Grid Minimum Off-Route Altitude; one degree latitude by one degree longitude in size and clears the highest elevation reference point in the grid by 1000 feet for all areas of the grid
Ground-Based Transceiver	Provides ADS-R, TIS-B and FIS-B broadcasts to ADS-B participating aircraft.
Groundspeed	The velocity that the aircraft is travelling relative to a ground position.
Ground Track	see Track
GS	Ground speed
Heading	The direction an aircraft is pointed, based upon indications from a magnetic compass or a properly set directional gyro.
Hg	mercury
hPa	hectopascal
hr	hour
HSI	Horizontal Situation Indicator
Hz	Hertz
IAF	Initial Approach Fix
IAT	Indicated Air Temperature
ICAO	International Civil Aviation Organization
IFR	Instrument Flight Rules

## Overview

ILS	Instrument Landing System
IMC	Instrument Meteorological Conditions
in	inch
Indicated	Information provided by properly calibrated and set instrumentation on the aircraft panel.

## Navigation

in HG inches of mercury

kg kilogram

kHz kilohertz

km kilometer

kt knot

## Flight Planning

LAT latitude

lb pound

Leg The portion of a flight plan between two waypoints.

LOC localizer

LON longitude

## Hazard Avoidance

## Additional Features

m meter

MAP Missed Approach Point

METAR Meteorological Aviation Routine

MHz megahertz

Minimum Safe Altitude Uses Grid MORAs to determine a safe altitude within ten miles of the aircraft present position.

MOA Military Operations Area

MSA Minimum Safe Altitude

MSL Mean Sea Level

## Appendices

## Index

NAVAID NAVigation AID

NDB Non-directional Beacon



NEXRAD	Next Generation Radar
nm	nautical mile(s)
OAT	Outside Air Temperature
OBS	Omni Bearing Selector
psi	pounds per square inch
QTY	quantity
rpm	revolutions per minute
SBAS	Satellite-Based Augmentation System
SD	Secure Digital
sec	second(s)
SIGMET	Significant Meteorological Information
TA	Traffic Advisory
TACAN	Tactical Air Navigation System
TAF	Terminal Aerodrome Forecast
TAS	True Airspeed
TCAS	Traffic Collision Avoidance System
TFR	Temporary Flight Restriction
TIS-A	Traffic Information Service
TIS-B	Traffic Information Service-Broadcast
Track	Direction of aircraft movement relative to a ground position; also 'Ground Track'
TRSA	Terminal Radar Service Area

Overview

Navigation

Flight Planning

Hazard Avoidance

Additional Features

Appendices

Index

## Overview

UTC Coordinated Universal Time

VFR Visual Flight Rules

VHF Very High Frequency

VNAV vertical navigation

VOR VHF Omni-directional Range

VORTAC very high frequency omnidirectional range station and tactical air navigation

VSI Vertical Speed Indicator

VSR Vertical Speed Required

VTF vector to final

## Flight Planning

WAAS Wide Area Augmentation System

WX weather

## Hazard Avoidance

## Additional Features

## Appendices

## Index

# APPENDIX K: LICENSE AGREEMENT AND WARRANTY

## CONTACT GARMIN

---

Contact Garmin if you have any questions while using your aera. In the USA contact Garmin Product Support by phone: (913) 397-8200 or (800) 800-1020, Monday–Friday, 8 AM–5 PM Central Time; or go to [www.garmin.com/support](http://www.garmin.com/support).

In Europe, contact Garmin (Europe) Ltd. at +44 (0) 870.8501241 (outside the UK) or 0808 2380000 (within the UK).

## SOFTWARE LICENSE AGREEMENT

---

BY USING THE aera, YOU AGREE TO BE BOUND BY THE TERMS AND CONDITIONS OF THE FOLLOWING SOFTWARE LICENSE AGREEMENT. PLEASE READ THIS AGREEMENT CAREFULLY.

Garmin grants you a limited license to use the software embedded in this device (the “Software”) in binary executable form in the normal operation of the product. Title, ownership rights, and intellectual property rights in and to the Software remain with Garmin.

You acknowledge that the Software is the property of Garmin and is protected under the United States of America copyright laws and international copyright treaties. You further acknowledge that the structure, organization, and code of the Software are valuable trade secrets of Garmin and that the Software in source code form remains a valuable trade secret of Garmin. You agree not to decompile, disassemble, modify, reverse assemble, reverse engineer, or reduce to human readable form the Software or any part thereof or create any derivative works based on the Software. You agree not to export or re-export the Software to any country in violation of the export control laws of the United States of America.

## LIMITED WARRANTY

---

This Garmin product is warranted to be free from defects in materials or workmanship for one year from the date of purchase. Within this period, Garmin will, at its sole option, repair or replace any components that fail in normal use. Such repairs or replacement will be made at no charge to the customer for parts or labor, provided that the customer shall be responsible for any transportation cost. This warranty does not cover failures due to abuse, misuse, accident, or unauthorized alteration or repairs. In addition, Garmin reserves the right to refuse warranty claims against products or services that are obtained and/or used in contravention of the laws of any country.

This product is intended to be used only as a travel aid and must not be used for any purpose requiring precise measurement of direction, distance, location, or topography. Garmin makes no warranty as to the accuracy or completeness of map data in this product.

THE WARRANTIES AND REMEDIES CONTAINED HEREIN ARE EXCLUSIVE AND IN LIEU OF ALL OTHER WARRANTIES EXPRESS, IMPLIED, OR STATUTORY, INCLUDING ANY LIABILITY ARISING UNDER ANY WARRANTY OF MERCHANTABILITY OR FITNESS FOR A PARTICULAR PURPOSE, STATUTORY OR OTHERWISE. THIS WARRANTY GIVES YOU SPECIFIC LEGAL RIGHTS, WHICH MAY VARY FROM STATE TO STATE.

IN NO EVENT SHALL GARMIN BE LIABLE FOR ANY INCIDENTAL, SPECIAL, INDIRECT, OR CONSEQUENTIAL DAMAGES, WHETHER RESULTING FROM THE USE, MISUSE, OR INABILITY TO USE THIS PRODUCT OR FROM DEFECTS IN THE PRODUCT. SOME STATES DO NOT ALLOW THE EXCLUSION OF INCIDENTAL OR CONSEQUENTIAL DAMAGES, SO THE ABOVE LIMITATIONS MAY NOT APPLY TO YOU.

Garmin retains the exclusive right to repair or replace the unit or software or offer a full refund of the purchase price at its sole discretion. SUCH REMEDY SHALL BE YOUR SOLE AND EXCLUSIVE REMEDY FOR ANY BREACH OF WARRANTY.

To obtain warranty service, contact your local Garmin authorized dealer or call Garmin Product Support for shipping instructions and an RMA tracking number. Securely pack the unit and a copy of the original sales receipt, which is required as the proof of purchase for warranty repairs. Write the tracking number clearly on the outside of the package. Send the unit, freight charges prepaid, to any Garmin warranty service station.

Online Auction Purchases: Products sold through online auctions are not eligible for rebates or other special offers from Garmin. Online auction confirmations are not accepted for warranty verification. To obtain warranty service, an original or copy of the sales receipt from the original retailer is required. Garmin will not replace missing components from any package purchased through an online auction.

International Purchases: A separate warranty is provided by international distributors for units purchased outside the United States. This warranty is provided by the local in-country distributor and this distributor provides local service for your unit. Distributor warranties are only valid in the area of intended distribution. Units purchased in the United States or Canada must be returned to the Garmin service center in the United Kingdom, the United States, Canada, or Taiwan for service.

## AOPA AIRPORT DIRECTORY NOTICE

AOPA MEMBERSHIP PUBLICATIONS, INC. AND ITS RELATED ORGANIZATIONS (HEREINAFTER COLLECTIVELY "AOPA") EXPRESSLY DISCLAIM ALL WARRANTIES, WITH RESPECT TO THE AOPA INFORMATION INCLUDED IN THIS DATA, EXPRESS OR IMPLIED, INCLUDING, BUT NOT LIMITED TO, THE IMPLIED WARRANTIES OF MERCHANTABILITY AND FITNESS FOR A PARTICULAR PURPOSE. THE INFORMATION IS PROVIDED "AS IS" AND AOPA DOES NOT WARRANT OR MAKE ANY REPRESENTATIONS REGARDING ITS ACCURACY, RELIABILITY, OR OTHERWISE. UNDER NO CIRCUMSTANCES INCLUDING NEGLIGENCE, SHALL AOPA BE LIABLE FOR ANY INCIDENTAL, SPECIAL OR CONSEQUENTIAL DAMAGES THAT RESULT FROM THE USE OR INABILITY TO USE THE SOFTWARE OR RELATED DOCUMENTATION, EVEN IF AOPA OR AN AOPA AUTHORIZED REPRESENTATIVE HAS BEEN ADVISED OF THE POSSIBILITY OF SUCH DAMAGES. USER AGREES NOT TO SUE AOPA AND, TO THE MAXIMUM EXTENT ALLOWED BY LAW, TO RELEASE AND HOLD HARMLESS AOPA FROM ANY CAUSES OF ACTION, CLAIMS OR LOSSES RELATED TO ANY ACTUAL OR ALLEGED INACCURACIES IN THE INFORMATION ARISING OUT OF GARMIN'S USE OF THE INFORMATION IN THE DATASETS. SOME JURISDICTIONS DO NOT ALLOW THE LIMITATION OR EXCLUSION OF IMPLIED WARRANTIES OR LIABILITY FOR INCIDENTAL OR CONSEQUENTIAL DAMAGES SO THE ABOVE LIMITATIONS OR EXCLUSIONS MAY NOT APPLY TO YOU.

## AC-U-KWIK LICENSE AGREEMENT

AC-U-KWIK AND ITS RELATED ORGANIZATIONS (HEREINAFTER COLLECTIVELY "AC-U-KWIK ORGANIZATIONS") EXPRESSLY DISCLAIM ALL WARRANTIES WITH RESPECT TO THE AC-U-KWIK INFORMATION INCLUDED IN THIS DATA, EXPRESS OR IMPLIED, INCLUDING, BUT NOT LIMITED TO, THE IMPLIED WARRANTIES OF MERCHANTABILITY AND FITNESS FOR A PARTICULAR PURPOSE. THE INFORMATION IS PROVIDED "AS IS" AND AC-U-KWIK ORGANIZATIONS DO NOT WARRANT OR MAKE ANY REPRESENTATIONS REGARDING ITS ACCURACY, RELIABILITY, OR OTHERWISE. LICENSEE AGREES NOT TO SUE AC-U-KWIK ORGANIZATIONS AND, TO THE MAXIMUM EXTENT ALLOWED BY LAW, TO RELEASE AND HOLD HARMLESS AC-U-KWIK ORGANIZATIONS FROM ANY CAUSES OF ACTION, CLAIMS OR LOSSES RELATED TO ANY ACTUAL OR ALLEGED INACCURACIES IN THE INFORMATION ARISING OUT OF GARMIN'S USE OF THE INFORMATION IN THE DATASETS. SOME JURISDICTIONS DO NOT ALLOW THE LIMITATION OR EXCLUSION OF IMPLIED WARRANTIES OR LIABILITY FOR INCIDENTAL OR CONSEQUENTIAL DAMAGES SO THE ABOVE LIMITATIONS OR EXCLUSIONS MAY NOT APPLY TO LICENSEE.

## FCC COMPLIANCE

This device complies with part 15 of the FCC Rules. Operation is subject to the following two conditions: (1) this device may not cause harmful interference, and (2) this device must accept any interference received, including interference that may cause undesired operation.

This equipment has been tested and found to comply with the limits for a Class B digital device, pursuant to part 15 of the FCC rules. These limits are designed to provide reasonable protection against harmful interference in a residential installation. This equipment generates, uses, and can radiate radio frequency energy and may cause harmful interference to radio communications if not installed and used in accordance with the instructions. However, there is no guarantee that interference will not occur in a particular installation. If this equipment does cause harmful interference to radio or television reception, which can be determined by turning the equipment off and on, the user is encouraged to try to correct the interference by one of the following measures:

- Reorient or relocate the receiving antenna.
- Increase the separation between the equipment and the receiver.
- Connect the equipment into an outlet that is on a different circuit from the GPS unit.
- Consult the dealer or an experienced radio/TV technician for help.

This product does not contain any user-serviceable parts. Repairs should only be made by an authorized Garmin service center. Unauthorized repairs or modifications could result in permanent damage to the equipment, and void your warranty and your authority to operate this device under Part 15 regulations.

## INDUSTRY CANADA COMPLIANCE

Category I radio communication devices comply with Industry Canada Standard RSS-210.

## RADIATION EXPOSURE STATEMENT

---

This equipment complies with FCC RF and IC RSS-102 radiation exposure limits set forth for an uncontrolled environment. This equipment should be installed and operated with a minimum distance of 20 centimeters between the radiator and your body.

This transmitter must not be co-located or operating in conjunction with any other antenna or transmitter.

The antennas used for this transmitter must be installed to provide a separation distance of at least 20 cm from all persons and must not be co-located or operating in conjunction with any other antenna or transmitter.

**A**

- Abnormal Operation 123
- Acquiring Satellites 4
- AC-U-KWIK 114, 129
- Additional Features 113
- ADS-B 110
- Aircraft Profile 161
- AIRMETs 88
- Airspace 64
  - Alert Messages 65
  - Smart 66
- Airways 48
- Alerts 117
  - Terrain 96
- AOPA 114, 129
- AOPA Data 39, 114
- Approach
  - Selecting 78
- ARTCC 64
- Aural Alerts 98, 121
- Autolocate 4
- Autozoom 18

**B**

- Backlight 24
- Baro Pressure 159
- Battery
  - Charging 3
  - Information 147
  - Installation 2
  - Life 147
  - Replacement 147
- BKSP 15
- Bluetooth 27, 28, 130, 146
- Bug Indicator 42

**C**

- Calibrated Airspeed 160
- CDI Scale 42
- Charge Mode 3
- Charging, the battery 3
- Cities 63
- Compass Arc 38
- Computer, connecting to 125
- Connecting, cables 135
- Copying, Flight Plans 76
- Course, setting 42

**D**

- Databases 125
- Data Entry 15
  - Alphanumeric Data 15
  - Predetermined Data Option 16
- Data Field
  - Options 37
- Data Field Options 117
- Data Fields 36
- Declutter 22
- Direct-to 67
  - Cancelling 68
- Display
  - Backlight Intensity 24
  - Backlight Timeout 24

**E**

- external GPS Antenna 146

**F**

- Files, managing 126
- Flight Log 155
- Flight Plan

Activation 74  
Active 71  
Copying 76  
Creation 70  
Data Fields 69  
Deleting 76  
Fuel Flow 75  
Inverting 77

FSS 64  
Fuel Flow 75  
Fuse, changing 147

**G**  
GDL 39 27, 81, 146  
GPS Navigation 35  
GPS Receiver Status 4  
GTX 330 141

**H**  
Hazard Display 123  
Heading Line 158, 159

**I**  
Indicated Altitude 159  
Interfacing 146  
Intersections 57  
Inverting, flight plans 77

**L**  
Location Formats 171  
Loss of GPS Position 123  
Lost Satellite Reception 5

**M**  
Managing Files 126  
Map

Autozoom 18  
Declutter 22  
Display Setup 46  
Orientation 46  
Overlays 22  
Panning 19  
Range 17, 18  
Symbols 22, 165  
Map Datum 171  
Map Feature  
  Button 19  
  Information 21  
Messages 117  
METARs 87  
MicroSD Card 127  
  Installing 127, 130  
Mounting, in aircraft 133

**N**

NDBs 57  
Nearest 11, 52  
  Airport Criteria 54  
Nearest Airport Criteria 30  
  Entering 30  
Nearest Type, Changing 31  
NEXRAD 85  
NMEA 141  
Numeric Data Options 119

**O**

Obstacle  
  Color Code 95  
Obstacles 94  
Option Menu 14  
Orientation, map 46  
Overlays  
  Displaying/removing 22



**P**

- Panning 7
- PIREPs 90
- POWER Button 4
- Present Position 31, 32
- Proximity Waypoints 163

**R**

- Red X 123
- Runways 50

**S**

- SafeTaxi 113
- Satellite Information 6
- Scrolling 7
- SD Card 125
- Searching the Sky 4
- Settings 23
- SIGMETs 89
- Smart Airspace 66
- Sound
  - Adjusting 25
  - Muting 26
- System Settings
  - Display 23, 26, 27

**T**

- TAFs 87
- Temperatures Aloft 87
- Terrain 93
  - Alerts 96
  - Audio 98
  - Aural Alerts 98
  - Views 95
- Tools 12

- Touchscreen 7
- Touchscreen, cleaning 148
- Track Log 156
- Traffic Data 100
- Traffic Ground Track 100
- Traffic Information Service (TIS-A)
  - Alerts 99
  - Configuring 141, 142, 145
  - traffic warning window 108
- Transferring Files 126
- Transponder 141

**U**

- USB Drivers 139
- User Waypoints 59
  - Creating 59
  - Deleting 62
- Utilities 155

**V**

- Vectors-to-Final 80
- Vertical Navigation (VNAV) 43
  - Profile 44
- VHF Comm Radio 137
- VORs 58

**W**

- Warranty 179
- Waypoints 49
  - Proximity 163
  - User 59
- Weather 54
- Weight & Balance 162
- WiFi Setup 28
- Winds Aloft 86

**Y**

Yoke Mount 134

**Z**

Zooming 8





Garmin International, Inc.  
1200 East 151st Street  
Olathe, Kansas 66062, U.S.A.  
Tel: 913.397.8200  
Fax: 913.397.8282  
Aircraft On Ground (AOG) Hotline: 913.397.0836  
Aviation Dealer Technical Support: 888.606.5482

Garmin AT, Inc.  
2345 Turner Road SE  
Salem, OR 97302, U.S.A.  
Tel: 503.581.8101  
Fax 503.364.2138

Garmin (Europe) Ltd.  
Liberty House, Hounslow Business Park  
Southampton, Hampshire SO40 9LR U.K.  
Tel: +44 (0) 238 052 4000  
Fax: +44 (0) 238 052 4004  
Aviation Support: +44 (0) 370 850 1243

Garmin Corporation  
No. 68, Zhangshu 2nd Road  
Xizhi District, New Taipei City, Taiwan  
Tel: 34-93-357-2608  
Fax: 34-93-429-4484

[www.garmin.com](http://www.garmin.com)